



Ranch Horse Association of Australia Incorporated

ABN: 91 265 387 186

2024/2025 Rule Book

www.rhaa.com.au

info@rhaa.com.au

*This rule book is an adaptation of the Australian Quarter Horse Rules
and is produced with the express permission of the AQHA.*



*Rules may be subject to change or amendment and are to take effect as at **1st August 2024**.*

TABLE OF CONTENTS

MISSION STATEMENT	5
THIS RULE BOOK SUPERSEDES ALL PREVIOUS VERSIONS	5
MEMBERSHIP & FEES	5
ANNUAL MEMBERSHIP:	5
YOUTH MEMBERSHIP.....	6
CLASS DIVISIONS:	7
Professional RIDERS	7
Non-Professional riders	7
The amateur must agree as follows:.....	8
MANDATORY FOR ALL LEVELS.	8
LEVEL 1 – GREEN:	9
Green Rider	9
Green Horse	9
Green Youth	9
Equestrian with disabilities	10
LEVEL 2 – INTERMEDIATE.....	12
Intermediate Rider	12
Intermediate Horse.....	12
Intermediate Youth.....	12
LEVEL 3:.....	12
Heritage Snaffle Bit	12
LEVEL 4:.....	12
Junior Horse	12
Senior Horse.....	12
Amateur	13
Select Amateur.....	13
Masters Amateur	13
Youth.....	13
ATTIRE:.....	13
WESTERN ATTIRE MANDATORY (All competitors).....	13
Optional Attire	13
GEAR:	13
LEVEL 1 GREEN.....	13
EQUESTRIAN WITH DISABILITIES (EWD)	14
LEVEL 2 INTERMEDIATE:	14

LEVEL 3 HERITAGE SNAFFLE BIT CLASS	14
LEVEL 4 OPEN	14
EQUIPMENT	14
TACK	16
OPTIONAL EQUIPMENT.....	16
Prohibited Equipment for showing.....	16
SHOW RULES.....	18
UNREGISTERED HORSES.....	18
SHOW RULES & ETIQUETTE:	18
WARM UP PEN RULES:.....	19
Large Arena Warm-Up Etiquette	20
MEMBER CODE OF CONDUCT:.....	21
SOCIAL MEDIA POLICY	22
MARSHALLING AREA CONDUCT & ATTIRE.....	22
CLASSES.....	23
RANCH RIDING	23
RANCH ON THE RAIL	25
RANCH PLEASURE	26
RANCH TRAIL.....	27
RANCH REINING	31
RANCH COW WORK	33
LIMITED RANCH COW WORK.....	36
RANCH CUTTING	37
RANCH ROPING.....	39
RANCH BOXING.....	41
RANCH PROSPECT LUNGELINE.....	42
RANCH PROSPECT TRAIL	45
RANCH PROSPECT CONFORMATION	46
RANCH CONFORMATION	46
ANIMAL WELFARE.....	47
RIDERS REPRESENTATIVE.....	50
JUDGING:	51
APPROVED SHOWS	55
APPROVAL.....	56
RANCH RIDING Pattern 1	58
RANCH RIDING Pattern 2.....	59
RANCH RIDING Pattern 3.....	60
RANCH RIDING Pattern 4.....	61

RANCH RIDING Pattern 5.....	62
RANCH RIDING Pattern 6.....	63
RANCH RIDING Pattern 7.....	64
RANCH RIDING Pattern 8.....	65
RANCH RIDING PATTERN 9.....	66
RANCH RIDING PATTERN 10.....	66
RANCH RIDING PATTERN 11.....	68
RANCH RIDING PATTERN 12.....	69
RANCH RIDING PATTERN 13.....	69
RANCH RIDING PATTERN 14.....	70
RANCH RIDING PATTERN 15.....	72
RANCH PLEASURE Pattern 1.....	73
RANCH PLEASURE Pattern 2.....	74
RANCH PLEASURE Pattern 3.....	75
RANCH REINING Pattern 1.....	76
RANCH REINING Pattern 2.....	77
RANCH REINING Pattern 3.....	78
RANCH REINING Pattern 4.....	79
RANCH REINING Pattern 5.....	80
RANCH REINING Pattern 6.....	81
RANCH REINING Pattern 7.....	82

MISSION STATEMENT

The Ranch Horse Association of Australia Inc (RHAA) is a not for profit, National Association dedicated to promoting "Ranch Horse" in Australia. Providing Ranch education, clinics, and events that support the growth of the free moving working horse and Ranch horse industry, providing uniform guidance & rules across Australia, whilst working in collaboration with the AQHA, PHAA, ASHS, AAA & the HSAA.

With representation from NSW, ACT, Victoria, Queensland, Tasmania, South Australia & Western Australia, the RHAA Inc formed a committee in October 2022, adopting a uniform set of rules to assist riders with all levels of experience and any breed of horse to enjoy all that Ranch has to offer.

THIS RULE BOOK SUPERSEDES ALL PREVIOUS VERSIONS

The rules published herein are effective **1 August 2024**, unless otherwise specified at the time of their enactment. These rules remain in effect except as superseded by rule changes enacted by the board of directors or executive committee as published on RHAA's website at rhaa.com.au. Refer to RHAA's website for the most updated version of the rules. Differences between rules published on RHAA's website and this handbook shall be governed by the official rules published on RHAA's website.

Every attempt has been made to indicate rule changes/modifications by bold lettering/underlining. Please read rules applicable to your activities in their entirety as changes/modifications may have occurred as compared to last published edition.

MEMBERSHIP & FEES

All Members are accepted on the same basis with equal rights: one ruling applies to all.

Membership falls due on the **1st of August**. All membership fees must be paid before entering/competing in any RHAA event.

ANNUAL MEMBERSHIP:

Membership fees from 1st August 2024, all prices include GST

Family	\$165.00
<i>EWD (must hold a single membership)</i>	\$41.25
Adult/Single	\$82.50
Youth	\$41.25
Day membership (no RHAA points)	\$41.25
Constituent	\$82.50
Life	\$770.00

Family Membership being 2 adults and their dependents 18 years of age and under, *residing at the same address*. Only (1) one nominated member will have voting rights. All members will hold the same membership number.

Single Membership single competitor 18Yrs and over

Youth Membership Riders 7yo to 18yo

Constituent

Life Membership

YOUTH MEMBERSHIP

An individual person, eighteen (18) years of age and under as of 1 August in the current show year, is entitled to apply for a Youth membership.

A parent/guardian, who has been nominated on the youth application/renewal of membership, must sign, or co-sign all Association paperwork relating to the Youth membership.

Youth Membership is offered to all Youth aged 18 years and under. If a Youth turns 19 during a year, he/she shall remain in Youth Classes for the duration of that year.

Youth may not ride or handle stallions at any time.

All Youth riders must have a responsible guardian on the grounds as per rules.

Youth members do not hold voting rights.

All Youth riders must wear an ASS approved safety helmet when mounted on a horse. Regardless of the division they are riding in.

Introduction:

This introduction is for the purpose of establishing eligibility for entries.

All breeds are permitted at any RHAA event and horses are not required to be registered to any breed society.

These rules are an adaptation of the AQHA rule book. Any open rules not covered, please see AQHA RULE BOOK.

CLASS DIVISIONS:

- Green Horse
- Green Rider
- Green Youth
- EWD
- Intermediate Horse
- Intermediate Rider
- Intermediate Youth
- Heritage Snaffle Bit
- Junior Horse
- Senior Horse
- Amateur
- Select Amateur
- Masters Amateur
- Youth
- Open
- Leadline

No horse shall be entered in more than three (3) divisions, including youth, per show or excessive classes as to cause mental or physical distress.

POINTS AND EXPERIENCE IN OTHER BREED AND DISCIPLINE ASSOCIATIONS FOR SIMILAR EVENT, SHOULD BE CONSIDERED WHEN ASSESSING ELIGIBILITY FOR A DIVISION. SHOW COMMITTEES AND RHAA HAVE THE RIGHT TO REFUSE ENTRY IN A CHOSEN DIVISION DUE TO PREVIOUS EXPERIENCE.

Unregistered horses must have a proof of age certificate supplied by a veterinarian to enter Amateur, Select Amateur, Youth or Open All Aged events.

PROFESSIONAL RIDERS

A 'professional' rider, HAS, in the previous three (3) years from the date of competing, received remuneration or compensation for. Showing or training any horse or instructing any other person in riding or exhibiting.

NON-PROFESSIONAL RIDERS

Person must be a financial member of the Association and hold either an individual Full, Life or Honorary Life membership in their own name

The amateur must agree as follows:

- Have not, in the previous three (3) years received remuneration or compensation for: Showing or training any horse or instructed any other person in riding, driving or exhibiting;
- Payment by another person for stable and or yard fees, bedding or camping fees will not be considered remuneration if the Amateur reimburses the payee;
- Prize money or judging fees will not be considered as remuneration;
- Amateurs may accept Sponsorship in the form of goods only.
- Exception would be Amateurs fundraising for a sanctioned RHAA event.

MANDATORY FOR ALL LEVELS.

- a) No horse under 3 years of age maybe exhibited.
- b) No hoof polish/black.
- c) No braided or banded manes/tails or tail extensions.
- d) Trimming inside ears is discouraged. Trimming bridle path is allowed, also trimming of fetlocks or excessive (long) facial hair.
- e) Equipment with silver should not count over a good working outfit. Silver on bridles and saddles is discouraged.
- f) Holding the saddle horn with either hand will not be penalised in any class.
- g) Posting or standing in stirrups at extended **trot** is acceptable.
- h) When exhibiting in a snaffle bit or hackamore, an exhibitor may switch between two hands and one hand on the reins at any time.
- i) No drag allowed in Level 1 (Green) or Level 2 (Intermediate), Heritage Snaffle Bit, **Green Rider** or Youth classes.
- j) Painted logs or poles are prohibited.
- k) Tie Breaker - specific manoeuvres and/or obstacles will be selected by Judge prior to start of the class and so noted on score sheets, these manoeuvres will be ranked as first tie breaker, second, third etc.
- l) Equipment failure that delays competition and/or becomes unsafe, the run is stopped, and the exhibitor will be given credit for what they have accomplished prior to that point but cannot place above other exhibitors who complete the pattern correctly and will be considered off pattern.
- m) Scoring Except for the Conformation class, each exhibitor is scored between 0-100 points and automatically begins the run with a score of 70 points.

LEVEL 1 – GREEN:

- Any age horse ridden two handed in a snaffle bit or hackamore **only**.
- **Any 'safe' saddle, with the exclusion of bareback pads. Includes. English, Western, stock, or fender saddles.** Cattle events must be ridden in Western, stock, or fender saddles ONLY.
- **10 cumulative points won per class/division** – rider is permitted to complete the season but must move up the following season
- Ownership of horse not required – a borrowed horse maybe used.

POINTS AND EXPERIENCE IN OTHER BREED AND DISCIPLINE ASSOCIATIONS FOR SIMILAR EVENT, SHOULD BE CONSIDERED WHEN ASSESSING ELIGIBILITY FOR A DIVISION. SHOW COMMITTEES AND RHAA HAVE THE RIGHT TO REFUSE ENTRY IN A CHOSEN DIVISION DUE TO PREVIOUS EXPERIENCE.

Green Rider

A class for inexperienced riders, open riders are NOT eligible for this class. Riders will be required to show their horses at the walk and trot only. **The purpose of this class is to encourage those new to riding and/or new to showing.** Those entered in this class are Ineligible for INTERMEDIATE or OPEN classes.

Green Horse

Open to all riders – professional and non-professional – **wanting to bring inexperienced horses** (3 years and over) into the show arena. Horses will be required to show at the walk, trot and lope. This class is aimed at giving green horses of all ages an opportunity to attain show experience.

Green Youth

A class for inexperienced Youth riders. Open to Youth up to 18 years as at 1st August. Riders will be required to show their horses at the walk and trot only. Must have written permission from their parent/guardian to be at that event. In the case of a Show the parent/guardian must also sign the entry form. All Youth competing or taking part in an RHAA sanctioned event must be in the care of a responsible adult who is in attendance for the duration of that event, whilst the Youth attends that event. The purpose of this class is to encourage Youth who are new to riding and/or new to showing in Ranch events. **Those entered in this class are ineligible for INTERMEDIATE Youth or YOUTH classes.**

No Ranch Cattle events or Ranch Reining available for Green Rider or Green Youth.

EQUESTRIAN WITH DISABILITIES

If an affiliate chooses to include EWD classes, the RHAA does not assume responsibility for safety of participants. It is Show Management which conducts these classes and controls both the physical facility and all aspects of the classes, responsibility for participant's safety remains solely with Show Management. At any time in this section of the Rule Book where a handler is mentioned that handler is optional and if a handler is used then they must be dressed appropriately being western style pants/jeans, enclosed safe shoes, shirt with sleeves and a western hat. The Judge can set their own patterns for these classes but must keep in mind the limitations of the exhibitors. Eg: No picking up objects, no dismounting.

In the case of adult participants, each participant needs to send to the RHAA a waiver that states the following:

I, name of address assumes all risk of personal injury or property damage and releases and discharges RHAA, RHAA Affiliates and Show Management, their respective Officers, Directors, representatives, and employees, from any and all liability, whenever or however arising, as to personal injury or property. Damage occurring as a result of participation in these classes, except for the negligent act or omission, if any, of said indemnities. If the participant is a minor, the parent or guardian, by allowing participation, assumes all risk of personal injury or property damage occurring as a result of the participation and does hereby release and discharge RHAA and Show Management, their respective Officers, Directors, representatives, and employees from any and all liability, whenever or however arising, from such participation, except for the negligent act or omission, if any, of an indemnity. Further, as parent or legal guardian, they agree to indemnify and hold harmless RHAA and Show Management from such liability to the minor.

- a) Each participant, and if a minor, the consenting parent or guardian, authorises the use of any picture, still or video which maybe taken in conjunction with the exhibitor's participation in these equestrians with disabilities classes for the RHAA's official uses.
- b) Only geldings or mares can be shown.
- c) **To show at an RHAA approved show, exhibitors must either be a member of the club running the show, or a member of AQHA if club is an AQHA affiliate for insurance purposes. Day membership is sufficient for this purpose. Please note however that only current RHAA members will be eligible to receive points towards RHAA end of year high point and lifetime awards.**
- d) An exhibitor cannot show more than one (1) horse in the same class and a horse cannot be shown by more than one exhibitor in the same class.
- e) Exhibitors cannot compete in the Open/Amateur/Youth classes and Equestrian with Disabilities classes at the same show. The exhibitor must make a choice for that show.
- f) For participation in these classes, an exhibitor must produce a Doctors Certificate, upon joining the RHAA for the first time, which states the disability. Competitors from other recognised breed organisations must have Equestrian with Disabilities endorsement from their breed. That every five (5) years an exhibitor must re-apply for a permit.
- g) Youth participants must be seven (7) years of age or older for the ridden classes. Classes are walk, or walk/trot only.
- h) Eligible Conditions Include:
 - Amputation
 - Arthrogyrosis
 - Aspergers Syndrome
 - Autism
 - Batten's Disease

Cerebrovascular Accident
Cerebellar Ataxia
Cerebral Palsy
Coffin Lowry Syndrome
Cystic Fibrosis
Down Syndrome
Dwarfism
Fragile X Syndrome
Friedreich's Ataxia
Guillain-Barre Syndrome
Hearing Impairment
Hunter's Syndrome
Juvenile Rheumatoid Arthritis
Intellectual Disability
Microcephaly
Multiple Sclerosis
Muscular Dystrophy
Post-Polio Syndrome
Prader-Willie Syndrome
Rhatt Syndrome
Spina Bifida
Spinal Cord Injury
Tourette Syndrome
Traumatic Brain Injury
Trisomy Disorders
Vision Impairment
Other diagnoses will be considered upon request.

- i) The exhibitor or their family does not have to own the horse.
- j) Handler – One (1) handler per entry in the arena to facilitate the safety of the rider. The handler must be eighteen (18) years of age or over. A halter must be on the horse, under the bridle, for use by the handler if needed. The handler must be appropriately attired and must have a suitable lead line in hand in case of need. Lead line cannot be fastened to the bit. Handlers will stand quietly as a group in a designated area of the arena unless their assistance is required and requested by the judge or ring steward.
- k) A competitor with a hearing impairment can have an assistant who communicates via sign language or cue cards to the competitor so they can conform to the Judge's directives. This
- l) assistant will be outside the arena and their position known to the Judge and ring Steward.
- m) Refer to "GEAR" in regard to required Tack and equipment.

The following disorders are not eligible:

- ADHD
- Anxiety Disorders
- Chronic Fatigue Syndrome
- Depression
- Dyslexia
- Eating Disorders
- Fibromyalgia
- Learning Disabilities
- Psychological Diagnosis

No Ranch Cattle events or Ranch Reining available for EWD.

LEVEL 2 – INTERMEDIATE

- Any age horse maybe ridden (Minimum 3Yo) one or two handed in any legal headgear
- Rider must not swap from one to two hands or visa versa during the class if riding in a curb bit.
- **Any safe saddle, with the exception of bareback pads. Includes. English, Western, stock or fender saddles permitted. Note: Cattle events must be ridden in Western, stock or fender saddles ONLY.**
- **10 cumulative points won per class/division** – rider is permitted to complete the season but must move up the following season.
- Ownership of horse not required – a borrowed horse maybe used.

POINTS AND EXPERIENCE IN OTHER BREED AND DISCIPLINE ASSOCIATIONS FOR SIMILAR EVENT, SHOULD BE CONSIDERED WHEN ASSESSING ELIGIBILITY FOR A DIVISION. SHOW COMMITTEES AND RHAA HAVE THE RIGHT TO REFUSE ENTRY IN A CHOSEN DIVISION DUE TO PREVIOUS EXPERIENCE.

Intermediate Rider

A class for non-professional riders with some previous show experience, professional riders are NOT eligible for this class. Riders will be required to show horses at the walk, trot & lope. Riders can ride in a snaffle, hackamore, or a curb bit with split reins or a romal. **Those entered in this class are ineligible for GREEN Rider classes.**

Intermediate Horse

Open to all riders – professional and non-professional. Horses with some previous show experience maybe shown in this class. Horses will be required to show at the walk, trot and lope.

Intermediate Youth

A class for Youth riders with some previous show experience. Open to Youth riders, 7 to 18 years as at 1st August. Riders will be required to show their horses at the walk, trot and lope. **Those entered in this class are ineligible for GREEN Youth or YOUTH classes.**

LEVEL 3:

Heritage Snaffle Bit

Open to horses 3 years and over. Ridden two handed in a snaffle bit regardless of horses age. Equipment: Fender or stock saddle. (NO western saddles permitted). *The purpose of this class is to encourage experienced riders from other disciplines, without necessitating the need to purchase a western saddle.

Those entered in this division, if eligible, can cross enter, Amateur, Select Amateur, Masters, Intermediate Rider, Green Rider and Youth.

LEVEL 4:

Junior Horse

Open to all horses 3-5Yo, regardless of rider level professional or non-professional. Can be ridden in a snaffle bit, hackamore, or curb bit one handed. Western saddles only.

Senior Horse

Open to all horses 6yo and over, regardless of rider level professional or non-professional. Horses MUST be ridden one handed in a bridle, split reins, romal or two rein. Western saddles only.

All Age Open maybe offered in place of or in additional to Junior and Senior horse.

Amateur

For those members of the Association, who are no longer eligible to exhibit in Youth classes, who are not professionals in the horse industry and who ride their horses for the pleasure of competing against other members who are also not professional.

Select Amateur

A person who has attained the age of 50 years and provides proof of age, which must be in the form of a copy of a driver's licence or birth certificate, who are not professionals in the horse industry and who ride their horses for the pleasure of competing against other members who are also not professional.

Masters Amateur

A person who has attained the age of 65 years and provides proof of age, which must be in the form of a copy of a driver's licence or birth certificate.

Youth

Open to all Youth 7 to 18 years of age. If one (1) class is held to be: 7 to 18 years old if two (2) classes held: 7 to 13 years and 14 to 18 years. Must have written permission from their parent/guardian to be at that event. In the case of a Show the parent/guardian must also sign the entry form. All Youth competing or taking part in an RHAA sanctioned event must be in the care of a responsible adult who is in attendance for the duration of that event, whilst the Youth attends that event. Youth MUST ride in correct headgear and attire as per RHAA Rules. A Youth can show non-owned horses in Youth classes and Open classes.

ATTIRE:

WESTERN ATTIRE MANDATORY (ALL COMPETITORS)

- long sleeve shirt, collar (band, stand-up, tuxedo, etc.)
- western hat (the hat must be on the rider's head when the exhibitor enters the arena) or ASS approved safety helmet. Safety standard numbers for these helmets are AS-NZS 3838, ARBHS 2012 and ASTM F1163.
- western pants/jeans
- western boots.

Optional Attire

Spurs, chinks, and chaps in ridden classes.

GEAR:

LEVEL 1 GREEN

- Any age horse to be ridden two handed in a snaffle bit or hackamore **only**.
- **Any 'safe' saddle, with the exclusion of bareback pads. Includes. English, Western, stock or fender saddles.** Cattle events must be ridden in Western, stock or fender saddles ONLY.

EQUESTRIAN WITH DISABILITIES (EWD)

- Equipment is to conform to the needs of the exhibitor and be suitable for the horse. Special adaptive equipment may be used where appropriate.

LEVEL 2 INTERMEDIATE:

- Any age horse may be ridden two handed in a snaffle bit or hackamore, or one or two handed in a curb bit.
- **Any 'safe' saddle, with the exclusion of bareback pads. Includes. English, western, stock or fender saddles. Note: Cattle events must be ridden in western, stock or fender saddles ONLY.**

LEVEL 3 HERITAGE SNAFFLE BIT CLASS

- Any age horse may be ridden two handed in a snaffle bit only. **Stock or fender saddle may be used, no western saddles.**

LEVEL 4 OPEN

- Western saddles compulsory. All other equipment requirements per the RHAA rules.
- **OPEN** (Junior Horse, Senior Horse as below)
- **Junior horse:** 3 to 5 years. Horse's five-years-old (5) and younger may be shown in a Snaffle bit, Hackamore, curb bit, half-breed or spade bit.
- **Senior Horse:** 6 years and over. Horse's six-years (6) and older can only be shown in a curb bit, half-breed, romal, spade bit or two rein (refer b. below)
- **Two rein:** The use of two-rein equipment is allowed in all ranch events for one year only.

EQUIPMENT

- a) Hackamore is the use of a flexible, braided rawhide or leather, or rope bosal, the core of which can be either rawhide or flexible cable. A Hackamore must use a complete Mecate rein which must include a tie-rein. Absolutely no rigid material is permitted under the jaws, regardless of how padded or covered. Horsehair bosals are prohibited. This rule does not refer to a so-called mechanical Hackamore.
- b) Two Rein. The purpose of the two-rein option is the transition between the hackamore and bridle and can be used on any aged horse all ranch events for one year only. The bit and bosal combination must be approved in accordance with the following.
Only one hand may be used on the reins and hands must not be changed. Any number of fingers between reins will be permitted. Both mecate and bridle reins are to be held in the rein hand. When using two rein equipment, bosals may be of any size, constructed of braided rawhide or leather and have a nonmetal flexible core. No iron or foreign substance may be used. The rider must use one hand on the reins. Fingers between the reins will be permitted.
- c) Snaffle Bit means the conventional O-ring, Egg-butt, or D- ring. The diameter of Snaffle bit rings must be a minimum of 50mm and a maximum of 100mm. The bars must be a minimum of 5/16" (8 mm) in diameter, measured one inch (25 mm) in from the cheek with a gradual decrease to center of the snaffle. The inside circumference of the ring must be free of rein, curb or headstall attachments which would provide leverage.
Reins must be bridged with the tails of the reins on the opposite side of the neck.

The rider's hands will be carried near the pommel and no further than approximately 50cm apart. Rider's hands must be steady with limited movement. Failure to comply with this rule will result in disqualification.

- d) Curb Bits means the use of a bit that has a solid or broken mouthpiece, has shanks and acts with leverage. All Curb bits must be free of mechanical device and will be considered a legal standard western bit.
- has a shank with a maximum length of 216mm to be measured as indicated in the diagram below.

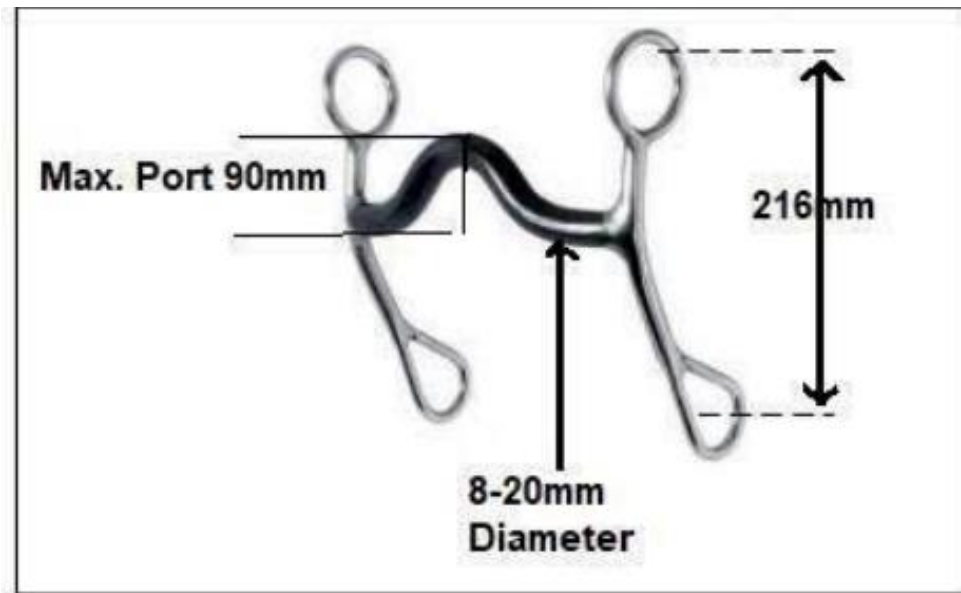

- Shanks maybe fixed or loose the port must be no higher than 90mm maximum, with rollers and covers acceptable. Broken mouthpieces, half- breeds and spades are acceptable. slip or gag bits, and donut and flat polo mouthpieces are not acceptable when using a curb bit, a curb strap or curb chain is required, but must meet the approval of the judge, be at least 12.5mm in width and lie flat against the jaw of the horse. A broken strap or chain is not necessarily cause for disqualification.
- e) Mouthpieces - the bars must be round, oval or egg shaped, smooth and unwrapped metal of 8mm to 20mm in diameter, measured 25mm from the cheek. They maybe inlaid but must be smooth or latex wrapped. Nothing can protrude below the mouthpiece (bar), such as extensions or prongs on solid mouthpieces than by no more than 1.6mm.
- f) The mouthpiece maybe two (2) or three (3) pieces. A three- piece will have a connecting ring of 32mm or less in diameter, or a connecting flat bar of 10mm to 20mm measured top to bottom, with a maximum length of 50mm, which lies flat in the horse's mouth or a connecting roller 10mm to 20mm diameter are acceptable.
- g) Except for Hackamore/Snaffle bit classes or junior horses shown with a Hackamore, only one hand must be used on the reins and the hand must not be changed and the index finger only must be between the split reins. Exception: To work a trail obstacle a rider may change hands on the reins, but the index figure only must be between the reins.
- h) Romal is an extension of braided material attached to closed reins. This extension will be carried in the free hand with 40cm spacing between the reining hand and the free hand holding the Romal.
- **The rider's hand will be around the reins with the wrists kept straight and relaxed, the thumb on top and the fingers closed lightly around the reins. Fingers between the reins is not allowed. The Romal will not be used forward of the cinch or to signal or cue the horse in any way.**

Acceptable:

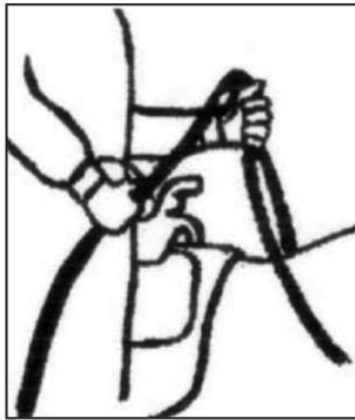

Unacceptable:



TACK

Standard mounted Western saddle with horn. Saddle without a horn is acceptable in Heritage Snaffle bit, Green & Intermediate levels. Horses must be ridden with a bridle having a bit in the mouth or with a hackamore. A bridle shall have no nose band or bosal and hackamores shall be of rope or braided rawhide with no metal parts. Braided rawhide balls across the horse's nose are not permissible. Choke ropes, tie downs, wire around the horse's neck, nose, or brow band, tight nose band, quirt, bat or mechanical device giving the rider undue control over a horse will not be permitted in the arena. Wire of any kind and on any part of the curb device is not permissible. Twisted wire bits are not permitted in any event.

OPTIONAL EQUIPMENT

- Rope or riata. If used, the rope or riata must be coiled and attached to the saddle.
- Hobbles attached to saddle.
- Tendon Boots, splint boots, bell boots, leg wraps and bandages are allowed in all classes except for Ranch Conformation.
- Glued on shoes are acceptable in all classes.
- Snaffle bit leather chin strap.
- Get down rope.

PROHIBITED EQUIPMENT FOR SHOWING

- Martingales
- Draw reins
- Nosebands and tie-downs
- Chain, wire, or metal tie-down or bonnets are prohibited, regardless of how padded or wrapped
- Training tack collars
- Jerk lines for roping
- English spurs
- Twisted mouthpieces
- Whips

Nutraceuticals or Herbal Therapies. The onus is on the Owner/Trainer/Handler/Exhibitor, who decides to administer these types of products to a horse, to ensure that they are free of any prohibited substance.

Surgical Procedures

A horse cannot compete if it has had any surgical procedure which could affect the horse's performance. Exception: for those surgical procedures performed by a duly licensed veterinarian for the sole purpose of protecting the health of the horse. If requested, a Veterinary Certificate detailing the surgery will be required. Artificial appliances are not permitted for use in approved classes. The following are not prohibited:

- conventional pads
- therapeutic shoes
- Pacemakers or prosthetic eyes, if the owner obtains written permission from the Association and the resulting authorisation is noted on the horse's entries.

Prohibited Drugs and Foreign Substances

A horse that has had any prohibited foreign substance or drugs administered internally or externally cannot compete.

- a) A patch of any type, medicinal or otherwise cannot be on a horse when that horse is being exhibited.
- b) A horse that is injured or taken ill once it has arrived at the official show venue, or whilst on the ground during the event, may compete after that horse has been treated by a Veterinarian at that show. The attending Veterinarian must sign a certificate which states:
 - what the horse is suffering from
 - what treatment, including any substances that have been administered internally or externally, and that the horse is sound enough to compete at that show.
- c) The certificate must be given to the Show Secretary and or Show Manager prior to the horse competing.
- d) A horse cannot be injected at a show unless the Veterinarian, that attended the horse at the show, has otherwise instructed. A Vet Certificate showing the treatment required must be obtained.

Acceptable Foreign Substances:

The following substances are acceptable:

- Antiprotozoals
- Anti-ulcer medication
- Insect repellent
- Anthelmintics
- Rehydration fluids
- B vitamins (orally)
- Regumate/Altrenogest (mares only)
- Topical ointments not containing Corticosteroids, irritant, or painkillers
- Preventative joint restorative therapies and general "over the counter" feed store supplements
- Every exhibitor will, upon request of show management or the Association representative, permit a specimen of saliva, urine, blood, or any other substance to be taken for testing. Refusal to comply with such a request will constitute grounds for immediate disqualification of the horse from further participation at the event. If the laboratory report on the chemical analysis of saliva, urine, blood,
- or other sample taken from the horse indicates the presence of a foreign substance, prohibited drug or medication, this will be taken as prima facie evidence such substance has been administered to the horse.

Penalties and Restrictions. Any person, member, or non-member, found in violation of these rules will be disciplined, suspended, fined, denied Association privileges, disqualified, expelled from the grounds, and/or expelled from the Association. If, upon examination by Association or show representatives, after Association authorisation, a horse's physiological functioning is found to be outside normal limits, the horse will automatically be reported to the Association. Upon written notification by the Association, the horse's participation privileges in Association approved events will be suspended pending a hearing to determine whether the horse's physiological functioning remains abnormal, with the burden of persuasion on the owner to prove normal physiological functioning. Participation privileges of the horse will remain suspended until any hearing.

SHOW RULES

The Club uses Ranch Horse Association of Australia (RHAA) rules for the conduct of events. Where RHAA Rules disagree with AUSTRALIAN QUARTER HORSE ASSOCIATION (AQHA) then the RHAA rules will override those of the AQHA.

- All horses entered must have turned 3 as at 1st August, prior to competing.
- Youth riders must wear an approved safety helmet at all times whilst riding on the Club grounds whether competing or not. Helmets must be ASS approved. Safety standard numbers for these helmets are AS-NZS 3838, ARBHS 2012 and ASTM F1163.
- **Judges engaged are to be AQHA VR and or RHAA approved.**
- Show Patterns will be supplied by the Judge.
- At ANY SHOW that runs an Approved RHAA program, an owner and / or exhibitor agree that the Association or show committee and their agents or representatives can photograph, video or tape any portion thereof the show, and use their likeness and that of the exhibited horses for training, promotional or other legitimate purpose without necessity of remuneration. Parental permission must be sought for use of Youth photos.

UNREGISTERED HORSES

- **Unregistered horses must have a proof of age certificate supplied by a Veterinarian to enter Youth or All Aged events.**

SHOW RULES & ETIQUETTE:

- Only paid & current Financial Members are permitted to be mounted on a horse at any event. Only horses entered in a minimum of one class are permitted on the grounds.
- Once a class is completed, you maybe asked to line up in the arena for presentation for placings. You must be mounted on a horse you showed in the class, in correct attire and line up in an orderly fashion (straight line). If a competitor has entered on multiple horses, another member of the RHAA in suitable attire, may ride the horse in for presentation. In the Ranch on the Rail class, you will remain to be judged, until ribbon is placed around horses' neck.
- The Committee reserves the right to remove any problem horse or rider from an arena and/or grounds if necessary.
- Show management reserve the right to change the order of classes before or during the show. It is the responsibility of the exhibitor to be aware of any changes which will be posted at the Show Secretary's office and/or announced.
- Every endeavour will be made to give one hours' notice of any changes to the running order of events.

- No training equipment is allowed in the marshalling area or the performance arena one (1) hour prior to the commencement of the show and one (1) hour after the cessation of the show, on each day of the show.
- No lunging or exercising of horses is permitted in any arena while horses are being ridden.
- No change of handler is allowed without advising the show office at least one hour prior to the event taking place.
- Show management may exclude horses from competition should there be any unnecessary delay on the part of the exhibitor in bringing the horse into the competition arena. Failure to report on final call will result in disqualification from the class.
- Protests must be made in writing to the show secretary and be lodged within 1 hour of the completion of the disputed event. A cash fee of \$50 must accompany any protest.
- A dispute committee shall consist of the Show Manager, one show committee member and one competitor as selected by committee.
- No alcohol is allowed in or can be consumed in the marshalling areas, working arenas or show pen/contest areas at any time.
- Only show officials will be allowed in the competition arena during the judging.
- The Show Manager or such person he/she appoints shall have sole discretion to eject any exhibitor from the said area for inhumane treatment and/or training of any horse or failure to observe the Rules and Regulations of the competition and the Rules and Regulations of the RHAA
- All horses must be serviceably sound, the Judge and or Show Manager have the right to exclude any horse seen to be lame or injured.
- Neither the Ranch Horse Association of Australia, nor the sponsors or show organisers will be liable for any damage or loss that may occur to any person or animal.

WARM UP PEN RULES:

For the safety of our exhibitors, RHAA has established the following Warm Up area protocol:

In warm up areas, no cell phones, ear buds or headphones are allowed. For the safety of riders, fencing (running/stopping) should only be during designated times or when few riders are in the arena. Riders should practice spins in the middle of circles only. Beginning 2 hours before the show starts and during competition, only riders entered in competition are allowed horseback in warm up areas, no bareback riding and no riding double during that time frame.

One Circle Warm-Up Arena Etiquette



Large Arena Warm-Up Etiquette

- Always go with the flow of traffic. If the arena is large enough for two sets of circles, follow the diagram with a set of circles going each direction.
- NEVER stop your horse in traffic, and ALWAYS look behind you before you stop or slow down.
- Always look where you are going and watch out for other riders.
- Don't tie horses in the warmup arena.
- No cell phones, headphones, or ear buds in arenas.

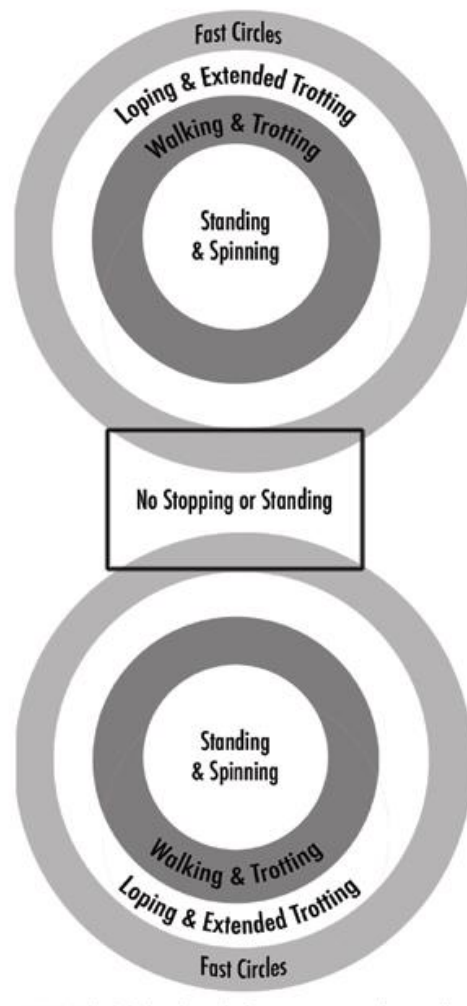

MEMBER CODE OF CONDUCT:

Competitors/participants of any event run by the RANCH HORSE ASSOCIATION OF AUSTRALIA have a responsibility to ensure the welfare of their horses and treat them humanely with dignity, respect, and compassion.

Competitors/participants are to conduct themselves in a professional manner and act with integrity in all dealing with the Association and other competitors and agree to uphold the rules and regulations of the RANCH HORSE ASSOCIATION OF AUSTRALIA at all times.

Competitors/participants are to demonstrate good sportsmanship at all times. Poor behaviour in the form of aggression, bad language or abuse of other competitors will not be tolerated. Persons involved in such behaviour maybe excluded from the show and maybe reported to the relevant breed association or society.

Any exhibitor or rider who refuses to obey the request of the Judge, Show Manager or any Show Official, will be automatically excluded from further competition at the show and forfeits all previous winnings together with all entry fees and other charges.

All competitors are to treat others with respect, always place the safety and welfare of children above other considerations, be responsible and accountable for their behaviour, follow the guidelines outlined in this policy if they wish to make a complaint or report a concern about possible child abuse, discrimination, harassment, or other inappropriate behaviours.

Committees are volunteers. Abuse or disrespect to any committee or show organiser will not be tolerated and incidents will be referred to the executive committee for discussion, and/or suspension or expulsion of a member.

SOCIAL MEDIA POLICY

Use Social Media appropriately. By all means share your positive experiences of RHAA but do not use Social Media as a means to breach any of the expectations and requirements of you as a Participant of RHAA. Do not make any public comment that is critical of the performance of a judge, competitor, official, or employee/ officer/volunteer/member of any affiliate or the RHAA or on any matter that is, or is likely to be, the subject of an investigation or disciplinary process; or otherwise make any public comment that would likely be detrimental to the best interests, image and welfare of the competition or Ranch industry.

Social Media means any form of online or interactive application or other form or medium that enables users to create, share and/or upload content, including SMS, MMS, email and such platforms as Facebook, WhatsApp, Myspace, Twitter, Snapchat, Instagram, TikTok, blogs, podcasts, message boards and websites. The Board may fine any offending member an amount of \$500.00 or if deemed a serious breach and appropriate refer the matter to a Disciplinary Committee.

MARSHALLING AREA CONDUCT & ATTIRE

For competitors in the marshalling areas and show arena, whilst show is in progress. Refer to Index (Attire).

- a) For handlers in the marshalling area, whilst show is in progress, is a minimum of cap/hat, long western style pants/jodhpurs, safe enclosed footwear and a shirt with sleeves
- b) For any person who has cause to enter the show arena to help set up trails etc. is a minimum of cap/hat, long western style pants/jodhpurs, safe enclosed footwear and a shirt with sleeves.
- c) For any person using the arena or marshalling area when the show is not in progress, but the show has not finished, is a minimum of long western style pants/jodhpurs, safe enclosed footwear, and a shirt with sleeves.

CLASSES

CLASS DESCRIPTIONS:

RHAA Class Name	AQHA Class Name
Ranch Riding	AQHA Performance Ranch Riding
Ranch on the Rail	AQHA VR Working Western Rail
Ranch Pleasure	AQHA VR Pleasure
Ranch Trail	AQHA VR Trail
Ranch Reining	AQHA VR Reining
Ranch Cow Work	AQHA VR Ranch Cow Work
Ranch Cow Work Limited	AQHA VR Limited Ranch Cow Work
Ranch Cutting	AQHA VR Cutting
Ranch Roping	
Ranch Boxing	AQHA Boxing
Ranch Prospect Lunge Line	AQHA Lunge Line
Ranch Prospect Trail	AQHA Led Trail
Ranch Prospect Conformation	AQHA VR Conformation
Ranch Conformation	AQHA VR Conformation

RANCH RIDING

The purpose of the Ranch Riding horse is to reflect the versatility, attitude, and movement of a working horse. The horse's performance is to simulate a horse riding outside the confines of an arena and that of a working ranch horse. This class will show the horse's ability to work at a forward, working speed while under control by the rider. Light contact will be rewarded, and the horse will not be shown on a full drape of reins. The overall manners and the horse's quality of movement are the primary considerations.

Class Requirements

- a) Each horse will work individually performing required and optional manoeuvres, and will be scored based on 0 to 100, with 70 denoting an average performance.
- b) Each manoeuvre will receive a score that should be added or subtracted, and scored on the following basis:
- c) The required manoeuvres will include the walk, trot, and lope both directions and the extended trot and extended lope at least one direction, (with the exception of walk/trot classes) as well as stops, and back.
- d) Three (3) optional manoeuvres may include a side pass, turns of 360° or more, change of lead (simple or flying), walk, trot or lope over a pole(s), or some reasonable combination of manoeuvres that would be reasonable for a ranch horse to perform.
- e) The manoeuvres may be arranged in various combinations with final approval by the Judge.
- f) The overall cadence and performance of the gaits should be with an emphasis on forward movement, free-flowing, and ground covering for all gaits. Transitions should be performed where designated, with smoothness and responsiveness.
- g) No time limit.
- h) The use of natural logs is mandatory, painted logs are prohibited.

The exhibitor is scored on the quality of each manoeuvre:

- Excellent +1½. Very Good +1. Good +½.
- Correct 0. Poor -½, Very poor -1, Extremely poor -1½.

Pluses and minuses reflect the smoothness, finesse, attitude, quickness, and authority of the exhibitor when performing the various manoeuvres.

Multiple penalties maybe incurred per manoeuvre.

Penalties

A contestant will be penalised each time the following occurs:

1 Point

- too slow (per gait)
- over-bridled (per manoeuvre)
- out of frame (per manoeuvre)
- break of gait at walk or trot for two (2) strides or less

3 Points

- wrong lead or out of lead
- draped reins (per manoeuvre)
- break of gait at lope except when correcting an incorrect lead
- break of gait at walk or trot for more than two (2) strides
- out of lead or cross-cantering more than two strides when changing leads
- trotting more than three strides when making a simple lead change
- severe disturbance of any obstacle.

5 Points

- blatant disobedience (kick, bite, buck, rear etc.) for each occurrence.

Off-Pattern (OP) Placed below horses performing all manoeuvres

- eliminates manoeuvre or adds manoeuvres
- incomplete manoeuvre
- use of two hands (except horses shown in a Snaffle bit/Hackamore or where division specific gear rules apply)
- more than one (1) finger between split reins or any fingers between Romal reins (except in the two-rein).

Zero (0) score will not be placed

- illegal equipment including hoof black
- braided or banded manes or tail extensions
- wilful abuse
- major disobedience or schooling
- lameness
- leaving the arena before completing pattern

No specific penalties will be incurred for nicks/hits on logs, but deduction made in manoeuvre score. No specific penalties will be incurred for over/under spins, but deduction maybe made in manoeuvre score. Tie Breaker Specific manoeuvres and/or obstacles will be selected by judge prior to start of the class and so noted on score sheets, these manoeuvres will be ranked as first tie breaker, second, third etc.

RANCH ON THE RAIL

The Ranch on the Rail class measures the ability of the horse to be a pleasure to ride and should reflect the versatility, attitude, and movement of a working horse.

The horse should be well-broke, relaxed, quiet, soft and cadenced at all gaits. The movement of the Ranch on the Rail horse should simulate a horse needing to cover long distances, softly and quietly. The overall manners and responsiveness of the horse and the horse's quality of movement are the primary considerations. Maximum credit should be given to the horse that has a natural flowing stride and consistent, ground covering gaits. Transitions should be performed when requested, with smoothness and responsiveness. The ideal Ranch on the Rail horse should have a natural head carriage at each gait. The horse should be ridden on a relatively loose rein with light contact and without requiring undue restraint while being responsive to the rider and making timely transitions in a smooth and correct manner. The horse should be soft in the bridle, yield to contact and shall not be shown on a full drape of rein. Riders are encouraged to use adequate space given the extension of gaits required. This class should show the horse's ability to work at a forward, working pace while under control by the rider. The horse shall be balanced and appear willing and a pleasure to ride in a group situation. This class is open to horses three years of age and older.

Class Requirements:

All exhibitors will work as a group. Individuals working off the rail will not be penalised and passing is permissible. Horses must work both ways of the ring at the walk, trot and lope.

Horses must work at least one way of the ring at the extended trot and extended lope. At the option of the judge,

- Horses maybe asked to extend their stride at the walk. The overall cadence and performance of the gaits should be with an emphasis on forward, free-flowing, and ground-covering movement.
- At the extended trot and lope, the exhibitor may post or stand in the stirrups. Touching or holding the saddle horn during any extended gait is acceptable.
- Horses are to be reversed to the inside (away from the rail). They maybe required to reverse at the walk or trot at the discretion of the judge but shall not be asked to reverse at the lope.
- Horses are required to back easily and stand quietly.
- Horses maybe brought to the center or backed on the rail.
- The rider shall not be required to dismount except in the event the judge wishes to check equipment.

Faults scored according to severity:

- Too slow (any gait)
- Excessive speed (any gait)
- Over-bridled (nose behind the vertical)
- Head carried too low such that the poll is below the withers
- Out of frame
- Head carried too high
- Break of gait
- Wrong lead or out of lead
- Failure to take the appropriate gait when called
- Opening mouth excessively
- Draped reins
- Use of spurs forward of the cinch
- **Over canted at the lope**
- Blatant disobedience (kick, bite, buck, rear, etc.)

Faults which will be cause for disqualification:

Head carried too low and/or clearly behind the vertical excessively and consistently while the horse is in motion, or otherwise showing the appearance of intimidation.

RANCH PLEASURE

The purpose of the Ranch Pleasure class is to measure the ability of the horse to be a pleasure to ride while being used as a means of conveyance from performing one property horse task to another. The horse should reflect the versatility, attitude, and movement of a working horse riding outside the confines of an arena. The horse should be well-trained, relaxed, quiet, soft, and cadenced at all gaits. The ideal ranch horse will travel with forward movement and demonstrate an obvious lengthening of stride at extended gaits. The horse is to be ridden with light contact or on a relatively loose rein without requiring undue restraint, but not shown on a full drape of reins. Overall manners and responsiveness of the **Ranch** horse to make timely transitions in a smooth and correct manner, as well as the quality of the movement are of primary considerations. The ideal **Ranch** horse should have a natural head carriage at each gait.

Horses will be shown individually, and the class maybe conducted inside or outside of an arena. The pattern maybe started either to the right or left direction. Show Management has the option to set markers to designate gait changes. If the class is held inside an arena, the course shall be set up to make approximately one pass of the arena in each direction. Any one of the **Ranch Pleasure** patterns maybe used or the Judge can provide another pattern if all elements of the class are fulfilled as follows:

- horses will be shown at three (3) gaits. walk, trot and lope in each direction of the arena.
- horses will also be asked to reverse, stop and back.
- the Judge must ask for an extended trot and extended lope at least one direction of the ring.

Credits and Penalties - Part of the evaluation is on smoothness of transitions. A horse maybe collected from the extended trot as the horse moves into the lope. The transition from the extended lope down to the trot is a transition to the seated trot not the extended trot. Therefore, an extra cue to achieve this gait is expected. Horses that complete this total transition within three (3) strides calmly and obediently should be rewarded. Horses that attempt to stop or do stop prior to trotting will be penalised. Judges expect to see horses that have been trained to respond to cues. To see these cues applied discretely and the horse responding correctly could be a credit-earning situation.

The exhibitor is scored on the quality of each manoeuvre:

- Excellent +1½. Very Good +1. Good +½.
- Correct 0. Poor -½, Very poor -1, Extremely poor -1½.

Pluses and minuses reflect the smoothness, finesse, attitude, quickness, and authority of the exhibitor when performing the various manoeuvres.

Multiple penalties maybe incurred per manoeuvre.

Penalties will be assessed as follows:

1 Point

- over-bridled (per manoeuvre).
- out of frame (per manoeuvre).
- too slow.
- break of gait at walk or trot for two (2) strides or less.

3 Points

- wrong lead or out of lead.
- draped reins.
- break of gait at lope, except when correcting an incorrect lead.
- break of gait at walk or trot for more than two (2) strides.
- out of lead or cross-cantering more than two (2) strides when changing leads.

5 Points

- spurring in front of cinch.
- blatant disobedience.
- use of either hand to instil fear/praise

Off-Pattern (OP)

Exhibitors cannot place above others who complete pattern correctly.

- repeated blatant disobedience.
- breaking pattern.
- incomplete manoeuvre.
- eliminating or adding manoeuvres.
- use of two hands (except horses shown in a Snaffle bit/Hackamore or where division specific gear rules apply)
- more than one finger between split reins or any fingers between
- romal reins (except in the two-rein).

Disqualification (DQ)

- lameness
- abuse
- illegal equipment, improper western attire
- disrespect or misconduct
- leaving working area before pattern is complete
- fall of horse/rider.

RANCH TRAIL

A Ranch Trail class should test the horse's ability to cope with situations encountered while being ridden through a pattern of obstacles generally found during everyday property work. The horse/rider team is judged on correctness, efficiency, and pattern accuracy with which the obstacles are negotiated, and the attitude and mannerisms exhibited by the horse. Judging emphasis is on identifying the well-broke, responsive, and well-mannered horse which can correctly navigate and negotiate the course.

Course

The Ranch Trail course will include no less than six (6) and no more than nine (9) obstacles. It is mandatory that the horse be asked to walk, trot and lope during the course.

Walk can be part of obstacle score or be scored with the approaching obstacle.

Trot must be at least 12m and score with approaching obstacle. Lope The lope must be lead-specific, at least 17m and score with approaching obstacle. Care must be exercised to avoid setting up any obstacles that maybe hazardous to the horse or rider.

Setting Courses

When setting courses, Judge/Management will be mindful that the idea is not to trap an exhibitor or eliminate them by making an obstacle too difficult. All courses and obstacles are to be constructed with safety in mind to reduce the risk for accidents. Show Committee/Judge shall have the option of setting up the trail course to best fit the arena conditions. An outdoor course is recommended if appropriate terrain is available. Each single- performance class can be time consuming, especially with large classes, so it is imperative that time restrictions are placed on this class. The Show Committee/Judge, either through a pilot run or estimation, shall select a course that has a continuous and positive flow that can be negotiated in four (4) minutes or less. The course must be designed using the mandatory obstacles and manoeuvres plus optional obstacles. Combining two or more of the obstacles is acceptable.

Mandatory Obstacles and/or Manoeuvres

- a) Ride over logs on the ground.
 - The formation of the logs will be a straight line, curve or zig zag and can be raised to a height of no more than 30cm.
 - walk, trot or lope maybe used but only one gait is required.
 - a maximum of five (5) logs to be used, with a maximum height of 25cm with spacing being:
 - Walkovers - between 66cm to 76cm
 - Trotovers - between 91cm to 107cm
 - Lopeovers - between 183cm to 213cm.
- b) Gate Opening, passing through and closing a hinged swinging gate (not a rope gate). Use gate that will not endanger horse or rider and requires minimum side-passing. **One hand only must be on the reins at all times whilst working the gate. Height 1.4m to 1.5m, gate opening 1.4m to 1.5m, latch or chain to be a minimum of 1.3m measured from the ground**
- c) Bridge to be sturdy, safe, and negotiated at a walk only. Heavy plywood lying flat on the ground is an acceptable simulation of a bridge. Suggested minimum width shall be 91cm wide and at least 183cm long.
- d) Backing an L, V, U or zig zag shape or in a straight line. Obstacles are to be spaced at a minimum width of 71cm and if elevated, maximum height must be 61cm.
- e) Side-pass any object which is safe and of any length maybe used to demonstrate responsiveness of the horse to leg signals. Raised side pass obstacles should not exceed 30cm.
- f) Drag an object – For Junior Horse, Senior Horse, Open and Amateur divisions only. Drag to be done at the walk or **trot**. Drag maybe a complete figure of eight and maybegin in either direction. The exhibitor must have the rope dallied on the saddle horn (half or full dally) for the duration of the drag. **NB: No drag in a Snaffle Bit, Youth, Green or Intermediate levels.**
- g) **Rope an object – For Junior Horse, Senior Horse, Youth, Open and Amateur divisions only. Roping must be performed on horseback. The exhibitor may use their own rope or rope provided. NB: No roping in Heritage Snaffle Bit, Intermediate or Green levels**

Optional Obstacles

Optional obstacles maybe used provided the obstacles can be found in everyday ranch work. Optional obstacles from which selections can be made are:

- a jump obstacle whose centre height is not less than 35cm or more than 63cm high. Holding the saddle horn is permissible for this obstacle
- only live or stuffed animals which would normally be encountered in an outdoor setting maybe used but not to be used to spook a horse
- carry object from one part of the arena to another
- remove and replace materials from a mailbox
- trot through cones spaced a minimum of 183cm apart
- cross natural ditches or ride up embankments
- swing rope or throw rope at a dummy steer head
- step in and out of obstacle
- put on slicker or coat
- stand to mount with mounting block
- walk through water obstacle
- open gate on foot
- pick up feet
- walk through brush
- ground tie (hobbles are allowed)
- lead at the trot

Prohibited Obstacles

- tarps
- water obstacles with slick bottoms
- pvc pipe used as a jump or walk over
- tyres
- rocking or moving bridges
- logs elevated in a manner that permits such to roll in a dangerous manner
- painted logs.

Judges must walk the course and have the right and duty to alter the course if it is not in keeping with the intent of the class. Judges may remove or change any obstacles they deem unsafe, non-negotiable, or unnecessarily difficult. Anytime a trail obstacle becomes unsafe during a class, it shall be repaired or removed from the course. If the course cannot be repaired and some horses have completed the course, the score for that obstacle shall be deducted from all previous draws in that class. When a ground tie obstacle is used in Trail, for horses ridden using Romal reins, reins are to be looped over the horn and a get down rope and hobbles are optional.

Pattern must be posted at least one (1) hour prior to competition.

Credits and Penalties

All runs begin upon entering the arena and any infractions are subject to penalty at that time (such as two hands on the reins, using either hand to instil fear or praise, etc.). The rider has the option of eliminating any obstacle, however this will result in being “off pattern” (OP) and the exhibitor will not place above others who have completed the pattern correctly. A Judge may ask a horse to pass on an obstacle after three refusals or at any time for safety concerns.

Credit is given to exhibitors that negotiate the obstacles correctly and efficiently. Horses should receive credit for showing attentiveness to obstacles and ability to negotiate through the course when the obstacles warrant it while willingly responding to rider’s cues on more difficult obstacles.

Quality of movement and cadence should be considered part of the manoeuvre score for the obstacle.

The exhibitor is scored on the quality of each manoeuvre:

- Excellent +1½. Very Good +1. Good +½.
- Correct 0. Poor -½, Very poor -1, Extremely poor -1½.

Pluses and minuses reflect the smoothness, finesse, attitude, quickness, and authority of the exhibitor when performing the various manoeuvres.

Multiple penalties maybe incurred per manoeuvre.

Penalties are assessed as follows:

1 Point

- over-bridled (per manoeuvre)
- out of frame (per manoeuvre)
- each hit, bite or stepping on a log, cone plant or any component of the obstacle
- incorrect or break of gait at walk or trot for two (2) strides or less
- both front or hind feet in a single-stride slot or space at a walk or trot
- skipping over or failing to step into required space
- split pole in lope-over
- incorrect number of strides, if specified
- one to two steps on mount/dismount or ground tie except shifting to balance.

3 Points

- wrong lead or out of lead
- draped reins
- break of gait at lope, except when correcting an incorrect lead
- break of gait at walk or trot for more than two (2) strides
- three to four steps on mount/dismount on ground tie.

5 points

- spurring in front of cinch
- blatant disobedience
- use of either hand to instil fear/praise
- knocking over/stepping out of or falling off an obstacle
- dropping an object required to be carried
- 1st or 2nd cumulative refusal
- letting go of gate
- five or more steps on mount/dismount or ground tie.

Off-Pattern (OP)

Exhibitors cannot place above others who complete pattern correctly.

- incomplete manoeuvre
- eliminating or adding a manoeuvre
- breaking pattern
- 3rd refusal
- repeated blatant disobedience
- failure to dally and remain dallied during the drag
- use of two hands (except horses shown in a Snaffle bit/Hackamore or where division specific gear rules apply)
- more than one finger between split reins or any fingers between romal reins (except in the two-rein)
- failure to open and shut gate, or failure to complete gate.

Disqualification (DQ)

- Lameness, abuse
- leaving working area before pattern is complete
- illegal equipment, improper western attire
- disrespect or misconduct
- Fall of horse or rider

RANCH REINING

The ranch reining class measures the ability of the ranch horse to perform basic handling manoeuvres with a natural head carriage in a forward looking manner. The ideal ranch reining horse should have a natural ranch horse appearance from head to tail in each manoeuvre. Patterns may be chosen from any of the ranch reining patterns or approved by the show management and judge.

Credits and Penalties

All runs begin upon entering the pen and any infractions are subject to penalty at that time such as two hands on the reins, using either hand to instill fear or praise, etc.

To rein a horse is not only to guide him but also to control his movement. The best reined horse should be willingly guided or controlled with little or no apparent resistance. All deviations from the exact written pattern must be considered a lack of or temporary loss of control and therefore a fault that must be marked down according to severity of deviation. The horse/rider team's overall performance should be credited for smoothness, finesse, attitude, quickness and authority of performing various manoeuvres while using controlled speed which raises the degree of difficulty and makes the horse/rider team more exciting and pleasing to watch.

The exhibitor is scored on the quality of each manoeuvre:

- Excellent +1½. Very Good +1. Good +½.
- Correct 0. Poor -½, Very poor -1, Extremely poor -1½.

Pluses and minuses reflect the smoothness, finesse, attitude, quickness, and authority of the exhibitor when performing the various manoeuvres.

Multiple penalties may be incurred per manoeuvre.

Penalties

½ Point

- starting a circle or exiting a roll-back at a trot for up to two (2) strides
- delayed change of lead by one stride where the lead change is required by the pattern description
- failure to remain a minimum of 6m from the wall or fence when approaching a stop and/or roll-back
- over-spin or under-spin up to ⅛ turn.

1 Point

- over-bridled (per manoeuvre)
- out of frame (per manoeuvre)
- out of lead in the circles, figure eights or around the end of the arena (this penalty is cumulative and will be deducted for each quarter of a circle the horse is out of lead)
- over or under spinning ⅛ to ¼ turn
- slipping rein.

2 Points

- break of gait
- freeze up in spins or roll-backs
- failure to stop or walk before executing a lope departure on trot in patterns
- failure to be in a lope prior to the first marker on run-in patterns
- failure to completely pass the specified marker before initiating a stop position
- trotting beyond two strides, but less than ½ circle or ½ length of the arena.

5 Points

- spurring in front of cinch
- blatant disobedience
- use of either hand to instil fear/praise.

Off-Pattern (OP)

Exhibitors cannot place above others who complete the pattern correctly.

- breaking pattern
- inclusion of manoeuvre (e.g. over or under-spinning, backing more than two (2) strides, etc.)
- trotting in excess of ½ circle or ½ length of the arena
- repeated blatant disobedience
- use of two hands (except horses shown in a Snaffle bit/Hackamore or where division specific gear rules apply)
- more than one finger between split reins or any fingers between romal reins (except in the two-rein).

Disqualification (DQ)

- lameness, abuse
- illegal equipment, improper western attire
- disrespect or misconduct
- leaving arena before pattern is complete
- fall of horse/rider.

RANCH COW WORK

The ideal Ranch horse must also be a cow horse and this class demonstrates and measures the horse's ability to do cow work. Holding the saddle horn is permitted. There is a time limit per exhibitor to perform the work depending on the division and the time begins when the cow is turned into the arena. If the time has not elapsed and the Judge is satisfied that all requirements of the class have been met, the Judge should blow the whistle for the exhibitor to cease work. The Judge may blow a whistle at any time for the exhibitor to cease work for safety reasons. Judges will give credit for what they have seen. Only the Judge may award a new cow to a contestant to replace a cow that will not honour a horse. If the Judge awards a new cow, the exhibitor has the option to refuse the new cow by continuing to work. If the exhibitor accepts the new cow, the time for working the cow will start over. If the exhibitor intends to accept the new cow, the exhibitor must pull up immediately. When multiple Judges are scoring, any one of the Judges may terminate the work or signal for a new cow.

The same horse and rider combination CANNOT enter both Ranch Cow Work and Limited Ranch Cow Work.

The Show Manager may appoint a "help horse and rider" for cattle events to assist with removing cattle from arena once run is completed.

Time Limits

- a) All divisions are allotted three (3) minutes to complete the work.
- b) When there is one (1) minute left, the announcer will announce, "one minute remaining". At end of allotted time the announcer will call "time".

There are three (3) parts to the class:

- boxing
- fence work
- roping *or* circling.

Boxing the Cow: The rider shall ride into the arena, face the cattle entry gate and signal for their cow to be turned into the arena. The cow shall be controlled on the entry end of the arena for enough time to demonstrate the horse's ability to hold the cow. If the cow does not immediately challenge the horse, the rider shall aggressively move in on the cow to demonstrate his horse's ability to drive and block the cow on the entry fence.

Fence Work: After the cow has been controlled on the entry end of the arena, the rider shall set the cow up and drive it down either side of the arena. The cow should be turned on the fence at least once in each direction. The first run for a turn shall be past the half-way mark of the arena. All turns down the side shall be completed before reaching the end fence.

Roping or Circling:

Show Committee are responsible for checking State cattle welfare rules. The exhibitor has the option of circling the cow in the middle of the arena in both directions in lieu of roping.

Exhibitors may circle or rope the cow but cannot combine the two to get credit for this portion of the run. To rope the cow, the exhibitor must be carrying a rope when the run starts. The exhibitor may pull up after the fence work, take down the rope and proceed to rope and stop the cow. The exhibitor must then rope the cow and bring it to a stop. In the roping portion of the class, two (2) throws are permitted, and the horse will be judged on two (2) manoeuvres: tracking/rating and stopping the cow. It is not necessary that the exhibitor catch to receive a score in the roping portion. The catch is legal if the cow looks through the loop and the rope pulls tight on any part of the animal. The rope maybe tied on or dallied.

Circling the cow. The exhibitor will manoeuvre the cow smoothly at least 360° in each direction without interference from the fence. The circle's size, symmetry, speed, and relative balance from right and left show control. Tightening the circles down with fast head- to-head speed will be a credit situation. The circles should be completed before the cow is exhausted. Once an exhibitor has committed to circling a cow, if the cow falls no new cow will be awarded. The exhibitor will complete the run by riding around the fallen cow to fulfil circling requirements. In the circling portion of the judging, one whistle will terminate the work and two whistles will award a new cow.

Credits - All runs begin upon entering the pen, any infractions (such as two hands on the reins, using either hand to instil fear or praise, etc.) are subject to penalty at that time.

Credit will be given:

Boxing: for the horse's expression and its 'cow sense' (i.e., making moves with little rider assistance). holding, controlling, and turning the cow. amount of work done. and the degree of difficulty of the work.

Fence Work: for making the first run past the centre of the arena. making turns right on the cow. and controlling a difficult cow.

Roping: for rating and following cow to allow rider the optimal roping position. stopping hard. and staying in the ground during the hold. Credits for each element of Roping range from minus 1½ to plus 1½.

Circling: when the horse works willingly. acknowledges the cow. and gets close enough to the cow to control the circles. Credits for Circling range from minus 1½ to plus 1½ points for each direction.

Penalties will be assessed as follows:

1 Point

- over-bridled (per manoeuvre)
- out of frame (per manoeuvre)
- loss of working advantage
- using the corner or the end of the arena to turn the cow when going down the fence
- changing sides of arena to turn cow for each length horse runs past cow
- working out of position
- slipping rein
- failure to drive cow past middle marker on first turn
- two-loop catch in amateur and Youth classes.

2 Points

- going around the corner of the arena before turning cow
- when working an animal in the open field (at least 6 m from the side of arena) and the animal gets within 1 m from the end fence before being turned
- failure to catch if roping in amateur and Youth classes.

3 Points

- exhausting or overworking the cow before circling or roping
- hanging up on the fence (refusing to turn)
- knocking down the cow without having a working advantage
- two-loop catch when roping in open class.

5 Points

- failure to turn the cow both directions on the fence
- spurring in front of cinch
- blatant disobedience
- use of either hand to instil fear/praise
- **runs out of time to rope cow**

Off-Pattern (OP)

Cannot place above others who complete pattern correctly.

- Turning tail
- failure to attempt any part of the class
- repeated blatant disobedience
- schooling after entering the arena prior to calling for cow
- schooling horse between cows if new cow is awarded
- loss of rope in open class
- use of two hands (except horses shown in a Snaffle bit/Hackamore or where division specific gear rules apply)
- more than one finger between split reins or any fingers between romal reins (except in the two-rein).

Disqualification (DQ)

- bringing the cow straight over backwards landing on its back or head with all four feet in the air
- lameness, abuse,
- illegal equipment, improper western attire
- disrespect or misconduct
- leaving arena before run is complete
- fall of horse/rider.

Note: If the rider runs out of time to rope, there will be no credit for the stop/hold manoeuvre. Riders may still earn credit for tracking/ rating, control/position and speed/ degree of difficulty.

LIMITED RANCH COW WORK

The same horse and rider combination CANNOT enter both Ranch Cow Work and Limited Ranch Cow Work.

The Show Manager may appoint a “help horse and rider” for cattle events to assist with removing cattle from arena once run is completed.

Content. Limited ranch cow work exhibitors are allotted one minute and forty-five seconds to complete the work. When there is 50 seconds left, the announcer will announce, “50 seconds remaining”. At one minute and forty-five seconds, the announcer will call for time. Exhibitors are not required to use all the allotted time but must ride until the judge whistles the end of the run or time expires, whichever occurs first. There are four parts to the work: boxing the cow. setting up the cow and driving it down the fence to the opposite end of the arena. boxing it at the opposite end of the arena, and then driving the cow past the middle marker again. There is no expectation that the exhibitor will make a fence turn, instead the drive down the fence demonstrates correct position and control around the corner.

Boxing the Cow --The rider shall ride into the arena, face the cattle entry gate, and signal for their cow to be turned into the arena. The cow shall be controlled on the entry end of the arena for a sufficient amount of time to demonstrate the horse’s ability to hold the cow. If the cow does not immediately challenge the horse, the rider shall aggressively move in on the cow to demonstrate his horse’s ability to drive and block the cow.

Set Up Cow, Drive Down Fence to Opposite End of Arena - After the cow has been controlled on the entry end of the arena, the rider shall set the cow up for driving down the side of the arena. When coming out of corner, the horse shall be close enough to cow to demonstrate control with cow against the fence. This distance and control should be maintained for approximately 1/2 to 3/4 the length of arena. Rider will then stop and release the cow and move horse toward center of arena to set the cow up for boxing.

Boxing the Cow at Opposite End of Arena - The exhibitor will regain control or hold the cow at end of the arena to demonstrate the horse’s ability to “hold” the cow.

Drive the Cow back down the fence (original side) past the middle marker and continue until the judge blows the whistle to show completion. While boxing the cow at the opposite end, if the rider loses control and allows the cow to cross the center line, the judge will whistle the end of the run. The rider will receive off pattern penalty (OP) for the run.

A help horse maybe used to push cattle back to yards once competitor has completed their run.

Credits

All runs begin upon entering the pen. any infractions (such as two hands on the reins, using either hand to instill fear or praise, etc.) are subject to penalty at that time. During Boxing, credit will be given for the horse’s expression and its ‘cow sense’ (i.e., making moves with little rider assistance). holding, controlling, and turning the cow. the amount of work actually done. and the degree of difficulty of the work. Credit will be given during Set Up Cow and Drive Down Fence for rating the cow. blocking the cow with pressure towards the end of the arena. driving the cow with control down the side of the arena. and controlling a difficult cow. Manoeuvre evaluations and penalty applications are to be determined independently. The following penalties will be applied to each occurrence and be deducted from the final score:

Penalties will be assessed as follows:

1 Point

- Over-bridled (per manoeuvre).
- out of frame (per manoeuvre).
- loss of working advantage.
- driving cow down the opposite fence (changing sides).
- working out of position.
- slipping rein.
- failure to drive cow past the middle marker on second drive before time expired.

3 Points

- knocking down the cow without having a working advantage
- losing a cow while boxing.

5 Points

- spurring in front of the cinch
- blatant disobedience
- use of either hand to instil fear/praise

Off-Pattern (OP)

- Turning tail
- failure to attempt any part of the class
- repeated blatant disobedience
- schooling after entering the arena prior to calling for cow
- schooling horse between cows (if new cow is awarded)
- use of two hands (except horses shown in a Snaffle bit/Hackamore or where division specific gear rules apply)
- more than one finger between split reins or any fingers between romal reins (except in the two-rein).

Exhibitors cannot place above others who complete the pattern correctly.

Disqualification (DQ)

- lameness, abuse
- illegal equipment
- improper western attire
- disrespect or misconduct
- leaving arena before run complete
- fall of horse/rider.

RANCH CUTTING

This class is judged on the ability of the horse to work a cow by separating it from the herd and holding it to demonstrate the horse's ability to work the cow. A single cow is cut from the herd and the horse must demonstrate its ability to work the cow.

Objective is to cut one or two cows, based on the division, from the herd and work the cow(s) with the assistance of two turn- back riders and two herd holders.

Show Management may supply two herd holders and two turn back riders, or exhibitors may supply their own helpers. If an exhibitor is a herd holder or turn back rider, he or she may use the horse that they are competing on or use a different horse. NB: Announcer to notify when one (1) minute remaining.

Open, Amateur and Intermediate

- a) There will be a two-minute time limit. Each exhibitor must work two head and has the option of ending their run before the two-minute limit or working the full two minutes. Working more or less than two cows will incur an Off Pattern (OP) score.

Youth and Green Horse

- b) For Youth and Green Horse competition, there will be a one and a half minute time limit. Each exhibitor may work **one cow** and has the option of ending their run before the one and one-half minute time limit or working the full one and one-half minutes. Working more than one cow will incur an Off Pattern (OP) score.
- c) Time will begin when a rider crosses a pre-determined and marked timeline prior to entering the herd. The rider will then quietly separate his/her cow from the herd.
- d) Unnecessary roughness or disturbing the herd excessively could result in disqualification.
- e) Ultimate credit will be given to the horses demonstrating excellence in the herd work by committing to, driving, setting up and working a cow in the centre of the arena with minimal disturbance to the herd.
- f) Horses will not be penalised for reining during the cutting portion but should display natural ability.

Scoring: 100 percent will be judged by the horse's ability and performance.

Penalties will be assessed as follows:

1 Point

- over-bridled (per manoeuvre)
- out of frame (per manoeuvre)
- losing working advantage
- toe, foot, or stirrup on the shoulder
- working out of position

3 Points

- cattle picked up or scattered
- spurring on shoulder
- pawing or biting cattle
- back fence
- hot quit.

5 Points

- horse quitting cow
- losing cow
- changing cattle after a specific commitment
- failure to separate a single animal after leaving the herd
- blatant disobedience.

Off Pattern (OP)

- turn tail
- failure to cut two cows (Open and Amateur)
- blatant disobedience
- working more or less cattle than required for division
- use of two hands (except horses shown in a Snaffle bit/Hackamore or where division specific gear rules apply)
- more than one finger between split reins or any fingers between romal reins (except in the two-rein).

Disqualification (DQ)

- Lameness
- abuse
- disrespect or misconduct
- illegal equipment
- improper western attire
- excessive disturbance of herd to the point that exhibitor is asked to leave the arena
- leaving arena before run is complete
- fall of horse/rider.

RANCH ROPING

Exhibitors are permitted to hold romals and tail in one hand. If exhibitor chooses to show this way they must enter the arena with reins in one hand and are not allowed to touch rein with off hand at any time during the class. Exhibitor may show in romal, split or one-piece reins. No tie-downs or martingales etc. maybe used in this class.

- a) The intent of this class is to show the ability of the horse and rider skill of handling cattle as if they were doctoring injured or sick cattle. Cattle should be handled as calmly and slowly as possible. The judge should judge this class as if the cattle belonged to him or her. Entry does not have to separate their cow from herd and should not receive credit for separation from herd. When cow is separated from the herd there should be no excessive running or cutting of the cow.
- b) This is a judged event with a 90 second time limit. Scoring is from 0 – 100, 70 denotes an average score. The rope must be thrown and the contestant may throw only two loops. Any attempt by exhibitor to trap, snare, or collar cow by holding onto the loop will be cause for disqualification. A second rope maybe used, but the total number of loops thrown may not exceed two (2). If a second loop is used it must be recoiled. The Honda on the rope used must be of a factory plastic breakaway design.
- c) Horse and rider must start from behind a starting line which will be located 1/3 of the arena length away from where ten (10) calves are held as a herd with each bearing a number 0 - 9. A random draw will be used to select the calf to be roped, and will be announced to the contestant when the horse crosses the starting line.
- d) Each contestant may have the option of using one (1) herd holder. The herd holder may cross the starting line. The sole duty of the herd holder is to assist in holding the cattle at the working end of the arena.
- e) The contestant must make a legal catch of the designated calf and dally up. A legal head catch is a loop that goes completely over the calf's head and honda can be broken by any part of the calf's BODY, BUT must go over the calf's head first. When the calf breaks free from honda, the Flag Judge will signal the end of the run.
- f) In youth division classes, only the youth exhibitor at their discretion may have their ropes tied to the saddle horn instead of dallying or they may dally.

- g) After catching, it is desired for the horse to remain facing the cow until the honda breaks. Turning away from the cow to make the honda break quicker will receive a 5 point penalty.

CREDITS

- Quietness in the herd.
- Handling the cattle.
- Position of the horse when cattle are roped.
- Facing to cow.
- Quality of loop.

OFF PATTERN (OP)

- **Failure to make a legal head catch**

DISQUALIFICATIONS:

- Running into or over cattle.
- Schooling.
- Whipping or hitting horse with rope.
- Half of herd crossing starting line.
- Thrown from horse.
- Fall to ground horse and/or rider
- Loss of rope.
- Roping the wrong cow/number or multiple cows.

PENALTIES:

1 Point

- Working out of position.
- Loss of working advantage.
- Holding cut too long without roping.

3 Points

- Picking up cattle in herd.
- Breaking the honda without a dally.

5 Points

- 2 loop run (second loop).
- Loss of cow (re-cut in the herd).
- Excessive running/scattering of herd.
- Blatant disobedience including kicking, biting, bucking, rearing or striking.
- Horse turns tail.
- **Turning away from the cow to make honda break quicker.**

RANCH BOXING

Boxing consists of single cow work (boxing) on the end of the arena. The goal of this class is to introduce the rider to the “boxing” phase of the cow work. Judging begins when the contestant enters the arena.

There will be no schooling between cows if a new cow is awarded. Each contestant upon receiving a cow in the arena will hold that cow on the prescribed end of the arena for fifty (50) seconds, demonstrating the ability of the horse and rider to control the cow. It is legal to hold the reins and Romal in one hand (rein hand) while boxing the cow. Time will begin when the gate closes behind the cow after being let into the arena. The Announcer or Judge will signal the completion of the fifty (50) seconds with a whistle or horn.

Scoring will be based on 60 - 80, with 70 denoting an average performance. The Judge may blow the whistle at any time to terminate the work. A score of zero (0) will be given if the work is not complete at that time. Each work will be limited to 50 seconds and, the Judge may request additional work at his/her option.

The Show Manager may appoint a “help horse and rider” for cattle events to assist with removing cattle from arena once run is completed.

Credits

- maintaining control of the cow always
- maintaining proper position
- degree of difficulty
- eye appeal
- timed worked.

Penalties are to be assessed, per occurrence, as follows for the boxing/cow work:

1 point

- loss of working advantage
- working out of position.

3 points

- loss of control and cow leaves end of arena.

5 points

- spurring or hitting in front of cinch at anytime
- blatant disobedience defined as kicking, biting, bucking, rearing, striking or obviously insubordinate.

Zero (0)

- turn tail
- using two (2) hands on the reins in a bridle or the two-rein
- balking
- out of control
- bloody mouth (inside)
- illegal equipment
- leaving work area before pattern is complete
- fall of horse or rider
- schooling between cows if new cow is awarded
- failure to quit working a cow after a new cow has been awarded

RANCH PROSPECT LUNGELINE

LUNGE LINE Yearlings, two (2) year old and three (3) year old only

The purpose of showing a horse on a lunge line is to demonstrate that the horse has the movement, manners/expression/attitude, and conformation to become competitive under saddle.

This class defines what it means to be a “Ranch Prospect”. Yearlings are not expected to demonstrate the behaviour or quality of a finished show horse, but only that performance necessary for a reasonable presentation to the Judge.

Therefore, the purpose of this class is to reward: quality of movement, manners, expression, attitude and conformation suitable to future performance and the horse is to be judged with its suitability as a future performer under saddle in mind.

Class Format

The class consists of two (2) sections and must be judged in the following order:

First Section

Conformation/Equipment Inspection – Each horse is to be inspected by the Judge on conformation, proper equipment and for evidence of abuse and inhumane treatment. Each exhibitor will walk into the arena to the Judge and halt for evaluation.

Horses will then trot off straight and around a cone and take a place on the wall inside the arena.

All entries will be inspected in this fashion and as the “trot-off” is administered, horses showing levels of lameness will be excused from the class at that time.

Second Section

Lunging Demonstration – The Judge will stand outside the lunging circle.

The lunging demonstration will begin at the sound of a whistle or other audible indicator when the horse has reached the perimeter of the circle. Time will not begin before the horse reaches this perimeter.

When the “begin” signal is given, the exhibitor will be allowed 1½ minutes to present the horse at all three (3) gaits in both directions.

At the end of the 1½ minutes, the signal will be given to signify the end of the demonstration.

Show management has the option of adding a “half-way” signal if they choose.

At the completion of their 1½ minutes the entry will retire from the lunging area and walk to the end of the arena. The horses are to stand quietly, on the wall, whilst the other exhibitors present their horses. Exhibitors can begin work in the direction of their choice (counter or clockwise).

Equipment

- a) Horses are to be shown in a plain working halter and plain lunge line.
- b) For the lunging demonstration, the only attachment allowed to the halter is the lunge line. Lead (leather, nylon, soft rope or mecate) is attached with a clip or leather strap to be fastened to the halter underneath the jaw of the horse. The use of a lunge whip is permissible
- c) Minimum length of the lead to be six (6) metres and must not exceed nine (9) metres.
- d) The lunge line must hang free from the halter without touching any part of the horse.
- e) No other equipment is allowed on the horse during the class. Mechanical or retractable lunge lines are not permitted.
- f) Only movement, manners/expression/way of going and conformation are being judged.

Attire

Conventional western attire is mandatory. The type of attire worn by the exhibitor is not to be a consideration in placing the horse if the attire meets the requirements stated above.

Gaits are to be judged according to the AQHA rules for Ranch Riding and Ranch Pleasure.

An exhibitor can show more than one (1) horse in a class providing the same handler exhibits the horse in both parts as described in Rule

Class Format. Other than in the execution of Rule 92.2, the exhibitor must have a handler correctly attired for this class, to hold any additional exhibit in the arena while awaiting finalisation of the class.

Scoring

Movement will count for 34 points of the total score. Judges are to evaluate movement based on the gaits

- a) Walk will be scored on a scale of 1 to 3 in each direction, with 2 being average. The horse must be walked long enough for the judge to have enough time to evaluate and score the walk. The change of direction turnaround at the walk may count for the second walk score on the official score sheet. Lower gait scores should reflect stumbling in the gait.
- b) Trot will be scored on a scale of 1 to 7 in each direction. Using a 7.5 m radius, the horse is to trot a minimum of half (1/2) a circle both directions of the ring. Lower gait scores should reflect stumbling in the gait.
- c) Lope or Canter will be scored on a scale of 1 to 7 in each direction, with four (4) being average. Using a 7.5 m radius, the horse is to lope or canter a minimum of one (1) full circle both directions of the ring.
Furthermore, any entry that fails to demonstrate the correct lead for one (1) full circle will not place over another entry that has demonstrated the correct lead in its entirety. Lower gait scores should reflect stumbling in the gait.
- d) Use of Circle - Scores for all gaits in both directions should reflect positive, consistent use of the radius of the circle. Extra credit will be given for full, extended use of the circle on a slightly loose line. Lower gait scores should reflect lack of full use of the circle.

Manners/Expression/Attitude will count for up to 14 points of the total score. Horses will be penalised for obvious signs of overwork and sourness such as ear-pinning, head-throwing, striking, tail wringing, or a dull, lethargic manner of going. Horses will also be penalised for dangerous behaviour such as excessive bucking, cutting into the circle, or running off. Additionally, incidental touching the horse with the whip, cross-cantering, balking, backing up on the lunge line and excessive urging from the exhibitor will be penalised accordingly.

Conformation will count for up to 6 points of the total score, using a scale of 1 to 6. The horse will be judged on conformation suitable to future performance as a Ranch Horse competitor. The judges are to look for a total picture, emphasizing balance, structural correctness, and athletic capability.

Use of the circle – overall score

Consideration will be given to how well or how poorly the horse/exhibitor team uses the 7.5 m radius of the lunging circle. A separate box on the scorecard is available to indicate an overall score, from 1 to 3 points, for use of the circle.

Circle Scores

It is the Judge's responsibility to evaluate the circles and incorporate use of the circle in the gait scores based on the following scale:

3 points Good to Excellent Use of the Circle

- horse consistently stays on the perimeter of the circle with slight looseness in the line. Horse turns around on the circle perimeter

2 points Average use of the circle

- horse is only slightly inconsistent in using the 7.5 m radius of the circle

1 point Adequate use of the circle

- horse is shown in a circle radius of less than 7.5 m

0 points General use of the circle

- potentially dangerous slack in the line
- horse pulls exhibitor out of the circle.

Penalties

5 point penalty per direction:

- failure to walk a minimum of two (2) horse lengths
- failure to trot a minimum of a quarter of a circle
- failure to demonstrate the correct lead, for a minimum of a quarter of a circle

Disqualification DQ:

- evidence of lameness the Judge will immediately excuse horse from the arena.
- blatant striking horse with the whip during the lunging demonstration that will cause forward or lateral movement
- fall to the ground by horse. A horse is deemed to have fallen when its shoulder and/or hip and/or underline touches the ground
- horse steps over or becomes entangled in the lunge line
- improper equipment, evidence of abuse, or other violation of AQHA rules
- failure to show at all three gaits in both directions
- exhibitor shows disrespect towards the Judge
- anytime the horse becomes detached from the handler
- failure to complete trot off for soundness in three attempts
- failure to ever demonstrate correct leads and/or gait as designated

RANCH PROSPECT TRAIL

Yearlings, two (2) year old and three (3) year old only

Mandatory obstacles choose three (3) from this list and at least three (3) different other obstacles are to be selected from the list of optional obstacles:

- a) Opening, passing through and closing gate. Use a gate that does not endanger horse or handler. Must be left hand push away gate.
- b) Horse must go over at least four (4) logs or poles. These can be in a straight line, curved or zig zag. Spacing must be: Walk over 30-50cm. Trot over 75-90cm.
- c) Backing obstacles to be spaced a minimum of 70cm apart. Back thru L Shape, V shape, U shape or similar shape.

Optional Obstacles, but not limited to:

- back through and around at least three (3) markers. Minimum ground space 70cm.
- lead horse over wooden bridge. Minimum width 90cm, minimum length 1.8m, maximum height from ground to top of bridge 30cm. Bridge must be sturdy, safe, without sides and negotiated at the walk only.
- serpentine obstacles at walk and/or trot. Spacing a minimum of 1.1m or 1.5m for trot.
- carry object from part of the arena to another (only objects that reasonably might be carried on a trail ride can be used).
- put on and remove slicker.
- remove and replace materials from mailbox.
- side pass – diameter of pole is maximum height of 15cm.
- an obstacle consisting of 4 poles each 1.5 to 2m long, laid in a square. Each contestant will enter the square by walking over pole as indicated. When all four feet are in the square, horse is to execute a turn as indicated and depart.
- a circle to walk/trot in. Approximately 6m in diameter to be marked out, with four (4) cones or similar safe objects.
- any other safe and negotiable obstacle which could reasonably be expected to be encountered on a trail ride and meets the approval of the Judge can be used.
- a combination of one or more of the obstacles is acceptable.

Prohibited Obstacles

- **tarps**
- **water obstacles**
- **pvc pipe used as a jump or walk over**
- **tyres**
- **rocking or moving bridges**
- **logs elevated in a manner that permits such to roll in a dangerous manner**
- **painted logs.**

RANCH PROSPECT CONFORMATION

Yearlings, two (2) year old and three (3) year old only

The purpose of ranch conformation is to preserve the ranch horse type, by selecting well-mannered horses in the order of their resemblance to the breed ideal and that are the most positive combination of balance, structural correctness, and movement with appropriate breed and sex characteristics and adequate muscling. The ideal Ranch conformation horse should have a natural ranch horse appearance from head to tail.

- a) **The Ranch conformation class must be held after the conclusion of the Ranch Prospect Lungeline and Ranch Prospect Trail.**
- b) **To be eligible to compete in the Ranch Conformation class the horse must be shown in at least one other Prospect class in division on the day of the show.**
- c) **Stallions, geldings and mares are exhibited in the same class. Exception: Youth – geldings and mares only.**
- d) **Horses are to be shown in a good plain working halter, rope, braided, nylon or plain leather. Horses will walk to the Judge one at a time.**
- e) **As the horse approaches, the Judge will step to the right to enable the horse to trot straight to a cone placed 15 m away. At the cone, the horse will continue trotting, turn to the left and trot toward the left wall or fence of the arena. After trotting, horses will be lined up head to tail for inspection by the Judge. Horses that fail to trot after 3 attempts will be disqualified. Judges may ask a competitor to trot their horse again if inadequate distance or soundness is at question.**
- f) **The Judge shall inspect each horse from both sides, front and rear and place the horses in order of preference.**

RANCH CONFORMATION

The purpose of ranch conformation is to preserve the ranch horse type, by selecting well-mannered horses in the order of their resemblance to the breed ideal and that are the most positive combination of balance, structural correctness, and movement with appropriate breed and sex characteristics and adequate muscling. The ideal Ranch conformation horse should have a natural ranch horse appearance from head to tail.

- g) The Ranch conformation class must be held after the conclusion of the other events. **Excluding Ranch Prospect Conformation which is held after the Ranch Prospect Lungeline and Ranch Prospect Trail classes.**
- h) To be eligible to compete in the Ranch Conformation class the horse must be shown in at least one ridden class in division on the day of the show.
- i) Stallions, geldings and mares are exhibited in the same class. Exception: Youth – geldings and mares only.
- j) Horses are to be shown in a good plain working halter, rope, braided, nylon or plain leather. Horses will walk to the Judge one at a time.
- k) As the horse approaches, the Judge will step to the right to enable the horse to trot straight to a cone placed 15 m away. At the cone, the horse will continue trotting, turn to the left and trot toward the left wall or fence of the arena. After trotting, horses will be lined up head to tail for inspection by the Judge. Horses that fail to trot after 3 attempts will be disqualified. Judges may ask a competitor to trot their horse again if inadequate distance or soundness is at question.
- l) The Judge shall inspect each horse from both sides, front and rear and place the horses in order of preference.

ANIMAL WELFARE

This Animal Welfare Policy applies to any sanctioned event held by the Association, its Affiliates and any organisation that has been given program approval.

No horse shall be entered in more than three (3) divisions, including youth, per show or excessive classes as to cause mental or physical distress.

The Riders Representative has the right to halt any behaviour observed towards any horse being abused or if there are any actions by any contestants detrimental to the best interests of the horse.

Humane Treatment - The Association will not tolerate inhumane treatment of a horse, or any other animal used in competition.

- a) No member or non-member will treat any horse or animal in a cruel or inhumane manner.
- b) Inhumane treatment includes but is not limited to all relevant animal welfare legislation and rules of the National Authorities controlling the applicable sport.
- c) In any equestrian sporting event, the welfare of the horse is always the primary consideration.
- d) No horse should be ridden or trained in such a way that it is subject to extended periods of mental or physical distress.
- e) Association members must comply with all relevant animal welfare legislation and rules. This applies to all horses exhibited at events sanctioned by the RHAA, RHAA Affiliates and at any event that has been given Association program approval.
- f) The Association encourages all members to follow best animal welfare practice in all their dealings with horses.

Responsibility An individual is responsible for the horse's condition if:

- they designate themselves on the entry form as the exhibitor or authorises another to designate him/her as the exhibitor on the entry form.
- they sign the entry form on behalf of themselves or another or causes an agent or representative to sign it.
- they physically participate in the class by riding or showing the horse.
- they are the actual trainer, having presented or caused to be presented the horse at the grounds for exhibition.
- both the exhibitor, designated on the entry form, and the person having actual possession of the horse, while physically participating in the event, are conclusively deemed to be authorised by the owner to execute all documents necessary, or convenient, to allow the horse's participation in an event approved by the Association, including documents pertaining to drug testing.
- an individual is prevented from performing their duties, including absolute responsibility for the condition of the horse/s, or is absent from the show, they must immediately notify the show secretary, at the same time appoint a substitute, and such substitute must place their name on the entry form or the exhibitor represents the owner regarding their horse(s) entered in an approved show.

Prohibited conduct but not limited to: No person on the grounds, including but not limited to barns, stall, practice areas or show arena, can treat a horse in a manner that includes:

- continuous and/or relentless pressure from the bit, legs, or spurs.
- placing an object, other than a legal bit, in a horse's mouth to cause undue discomfort or distress.
- placing a legal bit in a horse's mouth in an abnormal manner.
- leaving a bit in a horse's mouth for extended periods of time to cause undue discomfort or distress, broken skin and/or bleeding.
- tying a horse's head up (above the withers), back, or around in a manner as to cause undue discomfort or distress. the horse must be able to hold its head comfortably in a "normal" position.
- tying a horse in a stall without access to food or water for an extended period.
- use of excessive training techniques such as striking a horse's legs.
- excessive spurring or whipping.
- excessive spinning (defined as more than eight (8) consecutive turns in either direction).
- continuing to work or exhibit a horse which appears to be sullen, lethargic, emaciated, dehydrated, depressed, drawn or overly tired.
- breaking the skin and causing bleeding from the spur, bit, or any other equipment.
- riding or training in such a way that the horse is subject to periods of mental or physical distress.
- exhibiting a horse that has an open wound and/or shows traces of blood.
- using prohibited equipment on the horse at Association approved events.

Prohibited Any form of conduct that inhibits competition at Association approved events.

- Padding classes, by entering a horse(s) to fill a class to increase show points.
- Discouraging a potential competitor from entering a class.
- Any competitor inside the arena, assisting another competitor, maybe disqualified. Exception: EWD, Youth Lead Line and Youth Walk & trot classes.
- Attempting to reduce competition, or assisting in reducing competition by a member.
- Attempting to reduce competition by a non-member of the Association.
- Engaging in unsportsmanlike conduct including, but not limited to, inappropriate language.
- Carrying or consuming alcohol in the marshalling areas, working arenas or show pen/contest areas.
- Directing abusive or threatening conduct or language toward Association representatives.
- Entering any registered horse in any sanctioned event by a name other than that by which the horse is registered.

Penalties and Restrictions

Any person, member, or non-member, found in violation of these rules will be disciplined, suspended, fined, denied Association privileges, disqualified, expelled from the grounds, and/or expelled from the Association. If, upon examination by Association or show representatives, after Association authorisation, a horse's physiological functioning is found to be outside normal limits, the horse will automatically be reported to the Association. Upon written notification by the Association, the horse's participation privileges in Association approved events will be suspended pending a hearing to determine whether the horse's physiological functioning remains abnormal, with the burden of persuasion on the owner to prove normal physiological functioning. Participation privileges of the horse will remain suspended until any hearing. Any hearing under this Rule must be requested by the owner.

A conviction of an individual, under State or Federal Law, will constitute a presumed violation of these rules for an offence of cruelty to, or judicial confiscation of a horse.

The RHAA does not assume or accept duty or responsibility for safety at any sanctioned event regarding participants or any other third parties, or for the horses or other property thereof. As an express condition of privilege to participate at an RHAA approved show or sanctioned event, each horse owner, exhibitor, trainer and participant assumes the risks of participation and releases and discharges the RHAA, its officers, directors, representatives and employees, from any and all liability, whenever or however arising, as to personal injury, property damage occurring as a result of participation in a class/event conducted by the RHAA or RHAA Affiliate.

Show Committee is responsible for the.

- condition of event premises.
- conduct and competence of show staff and other representatives
- implementation of show activities and classes, and
- all other aspects of the event.

Incidents at Shows

- a) Will be investigated by the Show Manager.
- b) The Show Manager, informed of the incident, will speak to the alleged offender and inform him/her, that a report will be filed with the Association re this alleged incident.
- c) If the Show Manager cites an alleged incident, they must act as per this rule.
- d) If an exhibitor, owner, and/or his/her representative acting on behalf of the exhibitor, is found to have engaged in:
 - unsportsmanlike conduct
 - inhumane treatment of a horse, or
 - a breach of any rule in this Rule Book, then they will be reported to the Association.
- e) Any incident reported to the Association, will be sent to the Investigative Committee to determine whether the alleged incident is founded and if further action is required.
- f) The Association can give a warning, show fine and/or suspend the showing rights of the exhibitor, owner and/or his/her representative acting on behalf of the exhibitor/owner, to participate in future approved shows for such period as the Association deems appropriate.
- g) If an adverse decision is reached by the Investigative Committee, then the person in question has the right to appeal to the Executive Committee within 14 days of receiving the notification from the Investigative Committee of their decision.

RIDERS REPRESENTATIVE

The show committee must appoint a Riders Representative before the contest starts or hold a meeting before each contest starts for the purposes of electing a representative of the contestants or a liaison (provided that person is a member of good standing of the RHAA) to work between contestants and show management.

In the event the representative has to leave the show for any reason, he shall appoint a representative in his place for the duration of the show. Any representative elected or appointed must be a contestant. He must represent all contestants with the show management and be the sole liaison with the said management. He must report if he observes any horse being abused or if there are actions by any contestant detrimental to the best interest of the association such as the following: loud and profane language, drunkenness or being under the influence of intoxicants, use of devices not permitted by RHAA rules or any other infraction of standing rules.

A representative shall have no contact or communication with the judge(s) beyond that permitted to any contestant.

The appointed representative shall complete the Riders Representative form at completion of the event and hand to show management for lodgement with the RHAA.

Show Fines and Penalties.

- a) Probation Period will be from 30 to 90 days at the discretion of the Association. No privileges are denied, but any abuse during the probation period will be considered at the next highest level.
- b) Suspended Show Privileges will be from 3 months to 12 months at the discretion of the Association. All rights and privileges associated with Association sanctioned events and the Association Award System and Annual High Point Awards are denied during the period of suspension and presence on grounds of Association sanctioned events is prohibited.
- c) Fines imposed will be between \$100 to \$8,000 at the discretion of the Association. The quantum of any fine will be set out in writing to the party involved and 60 days will be given to pay the fine.
- d) Expulsion of a member is to be directed to the RHAA Disciplinary Officer in accordance with the RHAA Constitution.

Prohibited conduct at a show. If any RHAA Affiliate, and other Associations seeking show program approval, do not conform to the rules and regulations of the Association the following will apply:

- 1st Offence Warning
- 2nd Offence \$100 up to \$1,000 fine
- 3rd Offence No show approvals for three to six months

Fines: The quantum of any fine will be set out in writing to the party involved and 60 days will be given to pay the fine.

JUDGING:

Judging Divisions:

“A”. Limited prior judging experience. MUST ATTEND AN AQHA/RHAA WORKSHOP and pass the theory, video and/or live horse judging. Newly qualified “A” judges performance will be monitored by RHAA Judges Subcommittee.

“AA”. Accredited AQHA Versatility Ranch (VR) Judges, who have passed RHAA accreditation, plus recognised RHAA judges who have judged a minimum of five (5) shows.

“AAA”. Existing AQHA/RHAA VR Judges experienced in judging cattle events. MUST ATTEND AND PASS AN AQHA/RHAA cattle events test.

“AAA*”. Existing AQHA/RHAA VR Judges experienced in judging cattle events with multiple tickets (ie: NRHA, NCHA, NRCHA, RA etc).

All rules pertaining to Judging as contained in this Rule Book, and any supplementary rules, will be implemented by the Association.

Designation as a RHAA Judge is a privilege, not a right, bestowed & ratified by the RHAA committee, according to procedures formulated by the Association, to individuals whose equine expertise and personal character merit the honour. An individual’s conduct as a member, exhibitor and judge, and their ability must be exemplary. The Judging convenor has the right to contact any existing Judge regarding their Judging commitments and/or abilities.

All AQHA approved Judges must officiate at a minimum of one show per annum.
No Affiliate, that has gained show approval from the RHAA, can use the same Judge for two (2) consecutive shows.

After acceptance of a judging commitment, a judge will endeavour, with all reasonable effort, to judge the show, and will timely communicate to show management any inability to do so. If a Judge cannot fulfil their commitment, then it is the responsibility of that Judge, in liaison with the Organisation that has hired them, to find a replacement Judge.
Additionally, the judge will immediately file with the Association, a written explanation of such inability to meet the commitment, specifying the date and way they communicated it to show management.

DEFINITIONS

- a) An Accredited Judge is defined as a person who has met all the criteria required to hold an accredited judges’ ticket as approved by the RHAA.
- b) An AmQHA Judge is defined as a person who resides in the USA, and who has passed all the criteria approved by the AmQHA Judges Committee and can officiate at all levels.
- c) An AmQHA International Judge is defined as a person who does not reside in the USA, who has passed all the criteria approved by the AmQHA Judges Committee and can officiate at all levels of shows.

JUDGES CONDUCT

An individual's conduct as a Judge must be exemplary and is subject to continual Committee reviews. Definition of Exemplary conduct – That a Judge's conduct is of such a high standard, that it is an example for others to follow and thus worth imitating, therefore Judges must conduct themselves in a manner deemed by the Board of Directors as appropriate.

To make formal complaint against an RHAA Judge, such complaint must be in writing, signed by the complainant and contain the specific facts giving rise to the complaint, and be received by the Association within fourteen (14) days from the date of the occurrence.

If the alleged complaint is substantiated, then the individual's Judge's ticket maybe suspended or removed.

- a) If a Judge is suspended from Association membership, the individual will automatically be removed from the list of Judges and there will be no provision for automatic reinstatement as a RHAA Judge.
- b) Judges having their qualifications withdrawn or downgraded, have one (1) month to fulfil existing commitments.
- c) Upon regaining eligibility for judging credentials, the individual will apply for reinstatement after the expiration date of one (1) year from the date of their disqualification under the current procedures for admission of new applicants.

THE EVENT

A Judge will:

- a) Upon arrival in the city where they are to officiate, contact an official of the show and advise that person of their presence and location.
- b) Not appear on the grounds where the show is being held more than one (1) hour before judging.
- c) Not visit the horse stall area, nor visit with owners, trainers, exhibitors, or owners' representatives, nor inspect or discuss any horse entered in the show before the judging (including the day prior to the show).
- d) Not review the show catalogue until after the judging has been completed, but will be furnished a schedule of classes by the show management prior to the judging.
- e) Be present to meet their responsibilities under Association rules and regulations and will be available to assist show management in meeting its responsibilities of rule compliance.
- f) At all times act in a professional manner.

Attire

Western attire, including western hat, coat (except in extreme weather conditions), western style pants/jeans, long sleeve shirt with collar (band, stand-up, tuxedo etc), tie or neckwear, and western boots are mandatory apparel for an individual to wear whilst judging an RHAA approved show or program.

Placings

- a) Once a class has been judged, it will not be rejudged, and once the Judge has marked their record and placings are made, there will be no changing of the Judge's record.
- b) A Judge can change their judge's card/sheet if there is proper documentation and proof that a clerical error has occurred. Clerical errors must be corrected within a reasonable period, but not more than one (1) hour after the last class of the day.
- c) It is the responsibility of the Judge to ensure, prior to signing their card, that the number of entries, scores and placing's are correct.

Conflict

RHAA Judges are to be sensitive to any conflict of interest between the Association's objectives and their own personal business or pecuniary interest.

Each Judge is to refrain from using their official status to further one's own personal or financial purpose. When such conflict of interest arises, the Judge is expected to either withdraw the personal objective from the transaction in question or resign from the Association's judges list, so that he or she may pursue the personal objective. Breach of this ethical rule will be subject to review by the Judges Committee under the Association rules. Certain specific areas of obvious conflict of interest for Judges are as follows:

- a) Neither the judge nor members of their family will exhibit or act as agents, representatives in any capacity, or handlers of a horse at a show at which he/she is officiating.
- b) A horse cannot be shown under a Judge if that Judge has been the owner, trainer or agent in any capacity, or conditioner of that horse within the previous 30 days. Group lessons i.e. clinics, schools and seminars are exempt from the above rule
- c) A horse cannot be shown under a Judge if that Judge or their immediate family have exhibited that horse in the previous 30 days.
- d) A horse owned by a person(s) cannot be shown under a Judge if that Judge or their immediate family have exhibited the horse owned by that person(s) in the previous 30 days.
- e) A Judge will not judge a horse that is owned by anyone from whom he/she has received a salary, commission or any kind of remuneration for selling or buying any horse for that individual. or, whether or not the horse is concerned in a transaction, has been in any employ or has represented such individual in any capacity for remuneration, within one (1) month from the date of the subject show.
- f) Any RHAA Judge involved in the management of a show cannot officiate as a Judge at that Show.
- g) A Judge cannot judge a horse belonging to, or being exhibited by, any member of their immediate family. (Spouse, De facto partner, parents, child of the family, grandparents, brothers, sisters). If such a horse as specified is entered in a show, its entry fee will be refunded, and it is not to be exhibited.
- h) These specified areas of disqualifying conflict of interest are not exclusive and Association Judges are ineligible to judge another's horse in other situations not designated by the rule.
- i) If a Judge cannot exercise their objective influence, because of their connection with an owner, exhibitor, or anyone else connected with the horse, or, for that matter, if such connection would appear to others as possible bias, whether or not the Judge feels that they would be affected, a Judge must disqualify themselves.
- j) The Judge at any show may also be on any sifting or elimination committee necessary.
- k) After a Judge has accepted a judging assignment, exhibitors will not contact, by any means, nor attempt to contact, the Judge pertaining to their judging of any horse at that show
- l) No exhibitor will visit or socialise with a Judge the day prior to, or day of, the show.
- m) No exhibitor will request information from the Judge, or decisions made by that Judge, concerning any exhibit at a show at the time of the show or within the immediate seven (7) days following the show.
- n) A Judge will not conduct a clinic/training seminar the day prior to or day of judging a show/program.

FEES

Minimum pay for an AA, AAA Judge is expenses plus two hundred and fifty dollars (\$250.00) for a day of eight (8) hours or less and twenty dollars (\$20.00) per hour over the eight (8) hours in one day.

It is further recommended that the Judge work no more than ten (10) hours in one day. If the hours spent in judging are expected to run to an excessive length, the show management must consider hiring two (2) Judges.

AUTHORITY

A Judge may:

- a) Disqualify a competitor who has not fulfilled the requirements of a class as described by the Associations Rules and Regulations.
- b) Require the backing of the finalists only in a class where backing is required.

A Judge will:

- a) Order any person or horse from the competition for bad conduct of one or both or may disqualify any exhibitor for excessive abuse of a horse.
- b) Refuse entry into the arena or remove an entry from a class for improper attire and/or equipment.
- c) Eliminate any horse/exhibitor, as an entry, which they feel is in violation of the intent of the Association's conduct rules, or which they feel has not legitimately attempted to exhibit the horse to the best of the horse's ability.
- d) Penalise a horse for excessive or exaggerated switching or wringing of the tail.
- e) Not penalise a horse for the way it carries its tail nor for normal response with its tail to cues from its rider or when changing leads.
- f) *NB: If a Judge suspects that a horses' tail has been surgically or chemically altered or has had any item or appliance that restricts the movement or circulation of the tail, then the Judge must report this horse to the Association. Judges suspicion is not cause for the Judge to not place the horse.*
- g) Not call exhibitors off the rail at any gait other than a walk in a rail class.
- h) Have the authority to require the removal or alteration of any piece of equipment, or any piece of apparel, which in their opinion is unsafe and would tend to give a horse an unfair advantage or which they believe to be inhumane.
- i) Disqualify a horse that is exhibited with an open wound and/or shows traces of blood.
- j) Disqualify a horse who has a bleeding mouth in any class.
- k) Disqualify a horse if the horse appears sullen, dull, lethargic, emaciated, drawn or overly tired.
- l) Have the authority to place a horse in whatever position in a class they think is justified by the merits of the horse. The Judge's decision is final.

APPROVED SHOWS

Final program must be submitted to the Secretary no later than **21 days** prior to show date for approval.

EOY High Points will be collated upon submission by the Group/Club/Affiliate Secretary within 30 days to the RHAA Points Coordinator following completion of the show or the following fines will apply:

- **results received after 30 days \$200 fine.**
- **after 60 days \$400**

No further show approvals will be granted until fines are paid in full.

No Affiliate run event is sanctioned by the Association unless the Association has been notified in writing prior to the event taking place. Until such times as Show Approval is forthcoming from the Association, the event is not sanctioned by the Association.

- a) An Event Planning Checklist must be completed before commencement of any event and sent to the Association within fourteen (14) days of the completion of the event This pertains to any event run by an Affiliate.
- b) The rules in this Rule Book must be adhered to at all RHAA Affiliate events, including shows, and for organisations that been granted Program approval.
- c) The rules pertaining to Amateurs/Select Amateurs and Youth must be adhered to in all equine competitions.
- d) All horses present at an RHAA Affiliate show must be entered in the show. **Excluding cattle event help horses.**
- e) **Only current RHAA members will be eligible to receive points towards RHAA end of year high point and lifetime awards.**
- f) A person expelled or suspended or not in good standing with the Association cannot exhibit or act as a handler/strapper at any RHAA approved event.
- g) Points will not be awarded to any horse exhibited or handled by a person so expelled, suspended or not in good standing with the Association.
- h) Persons as described above are prohibited from entering the official marshalling areas and show arena at any time for the duration of any event that has RHAA approval.

APPROVAL

- a) No show of any kind will be permitted to be held, by an RHAA Affiliate, on the dates of the Associations Annual General Meeting
- b) No show approval will be given for any identity, on the same day as an already approved show or program, within 150km normal road distance from venue to venue, unless written permission is given by the Affiliate who has that date approved.
- c) Shows or programs, that have been granted approval in the following point's year, are subject to any rules that become effective from 1 August of that year.
- d) **Results must be provided to the association within 30 days of the event.**
- e) **Affiliates may apply for approval and they must:**
 - a. **apply 21 clear days prior to the show.**
 - b. lodge the name of the Judge with the Association 21 days before the first day of the show.
- f) No approval will be considered until all paperwork, as requested by the Association, has been lodged and is complete and correct.
- g) All approved shows and programs, depending on the type of program must be officiated by **an AQHA VR or RHAA Judge**
- h) If approval is sought to run Equestrian with Disabilities recognised classes, then the Show Committee assumes the responsibility for safety of all competitors.
- i) Show or program approval is a privilege, not a right, granted or rejected at the RHAA's discretion according to continuous evaluation of the applicant including, but not limited to,
 - competence of show committee.
 - enforcement of RHAA Rules and Regulations.
 - quality of event.
 - service to RHAA members.
- j) Approval does not carry from year to year but must be obtained for each individual event and the RHAA reserves the right to approve only the number of shows or programs per calendar year as it deems appropriate for any Affiliate/Organisation.
- k) Changes cannot be made to an approved program that affects the approval of such program.
- l) If the application for approval is satisfactory, the RHAA will issue a statement of approval. If approval is not granted, then the Association, in writing, will stipulate the reasons why.

RHAA SHOW PATTERNS

All patterns and pattern descriptions are adopted from the AmQHA Rule Book



RANCH RIDING PATTERN 1

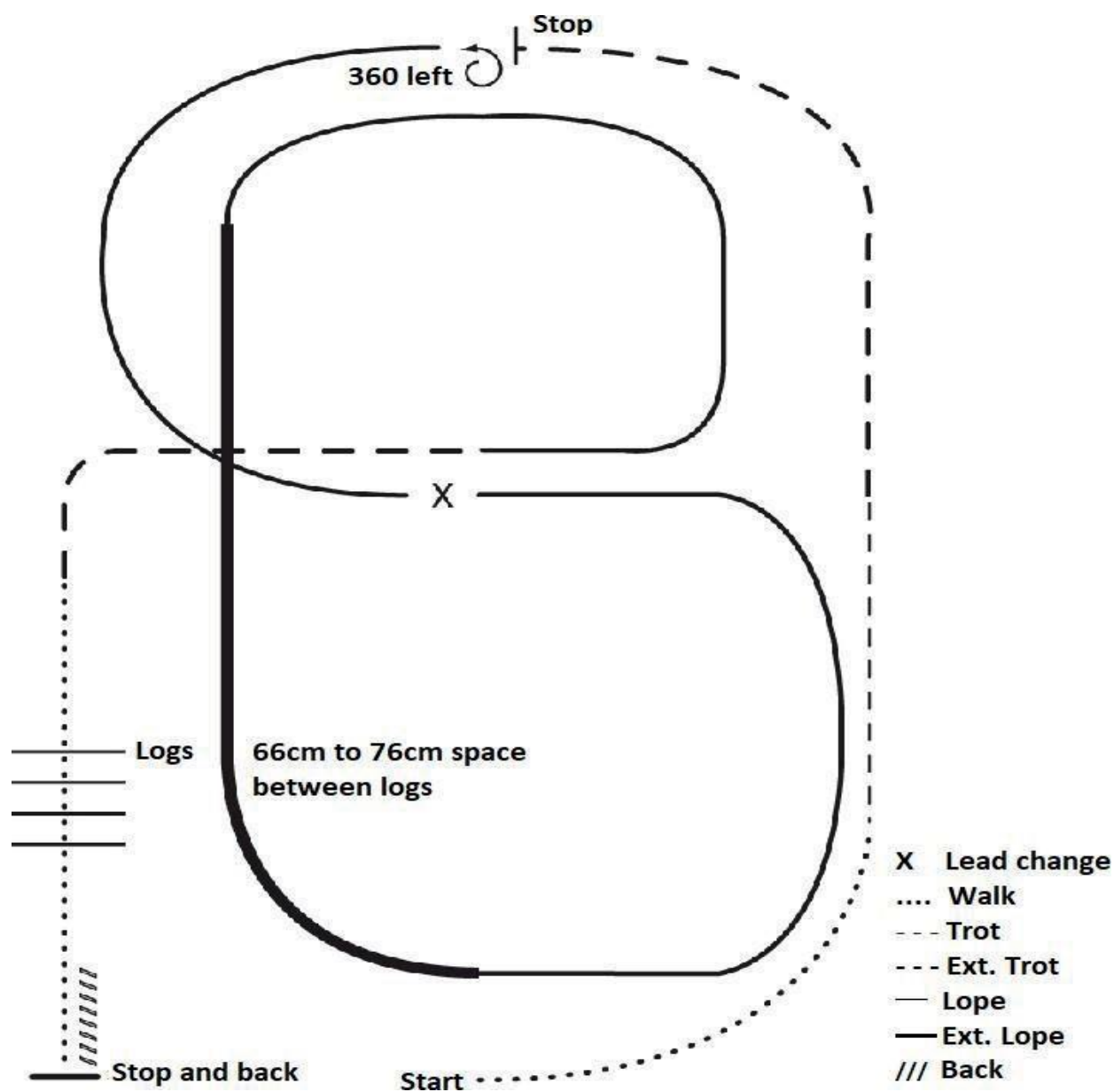

1. Walk
2. Trot
3. Extend the trot, at the top of arena, stop
4. 360° turn to the left
5. Left lead ½ circle, lope to centre
6. Change leads (simple or flying)
7. Right lead ½ circle
8. Extended lope up the long side of the arena (right lead)
9. Collect back to a lope around the top of the arena and back to centre
10. Break down to an extended trot
11. Walk over logs
12. Stop and Back

RANCH RIDING PATTERN 2

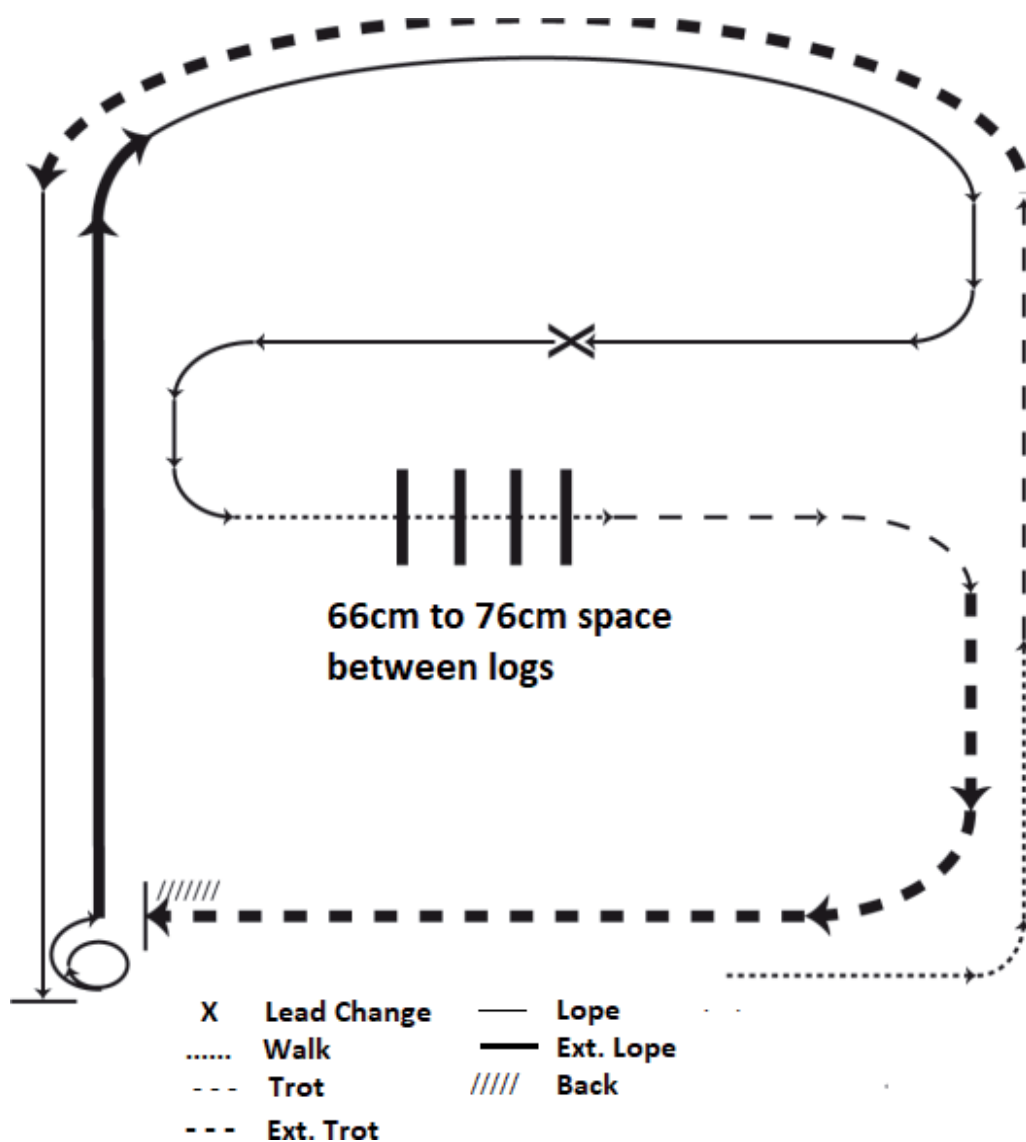

1. Walk
2. Trot
3. Extended Trot
4. Left lead lope
5. Stop. 1½ turn right
6. Extended lope
7. Collect to working lope, right lead
8. Change leads (simple or flying)
9. Walk
10. Walk over logs
11. Trot
- 12.** Extended trot
- 13.** Stop and back

RANCH RIDING PATTERN 3

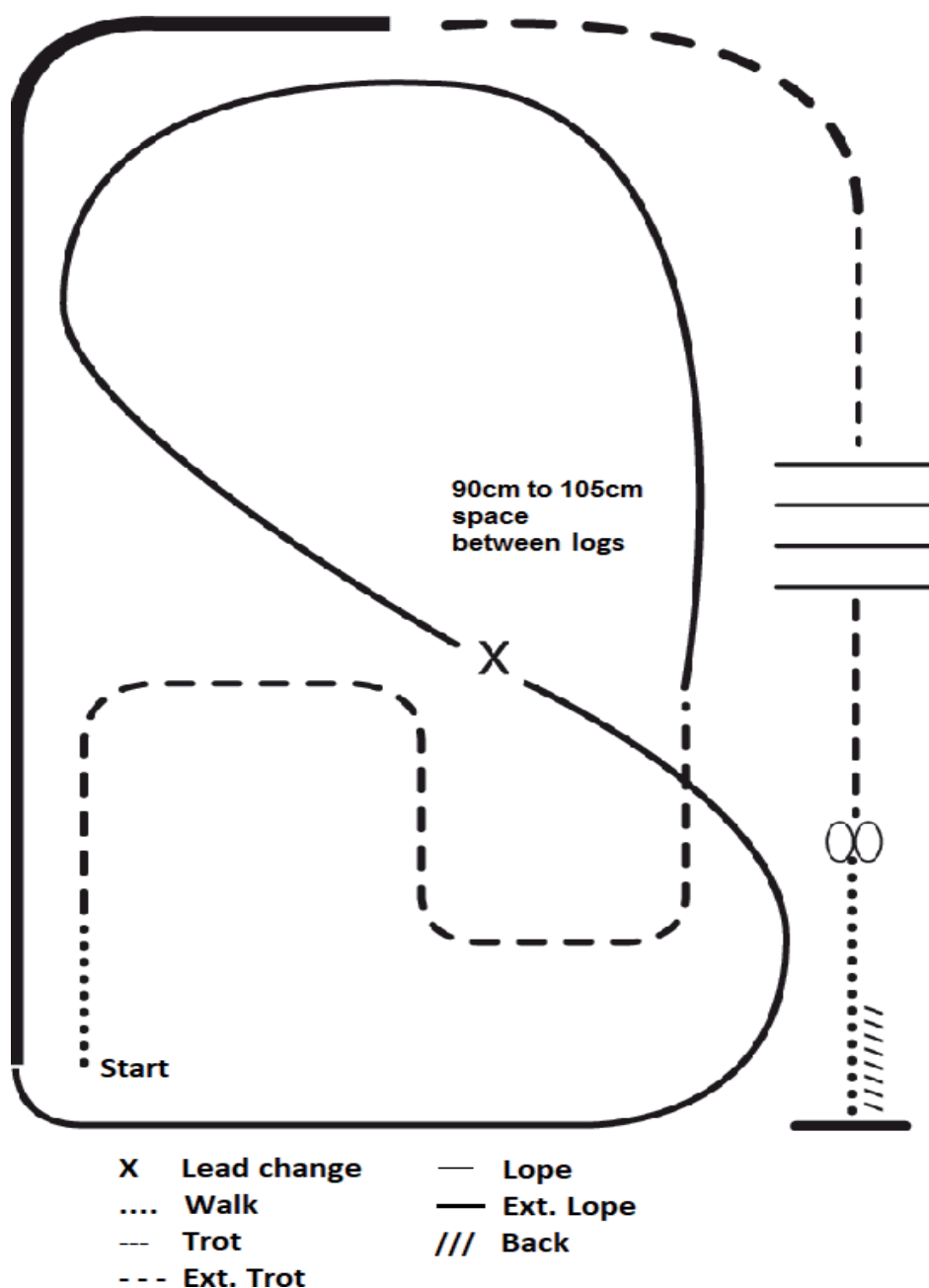

1. Walk
2. Trot serpentine
3. Lope left lead around the end of the arena and then diagonally across the arena
4. Change leads (simple or flying) and
5. Lope on right lead around end of arena
6. Extend lope on the straight away and around corner to the centre of the arena
7. Extend trot around corner of arena
8. Collect to a trot
9. Trot over logs
10. Stop, perform 360° turn each direction (either direction first)
11. Walk, stop and back

RANCH RIDING PATTERN 4

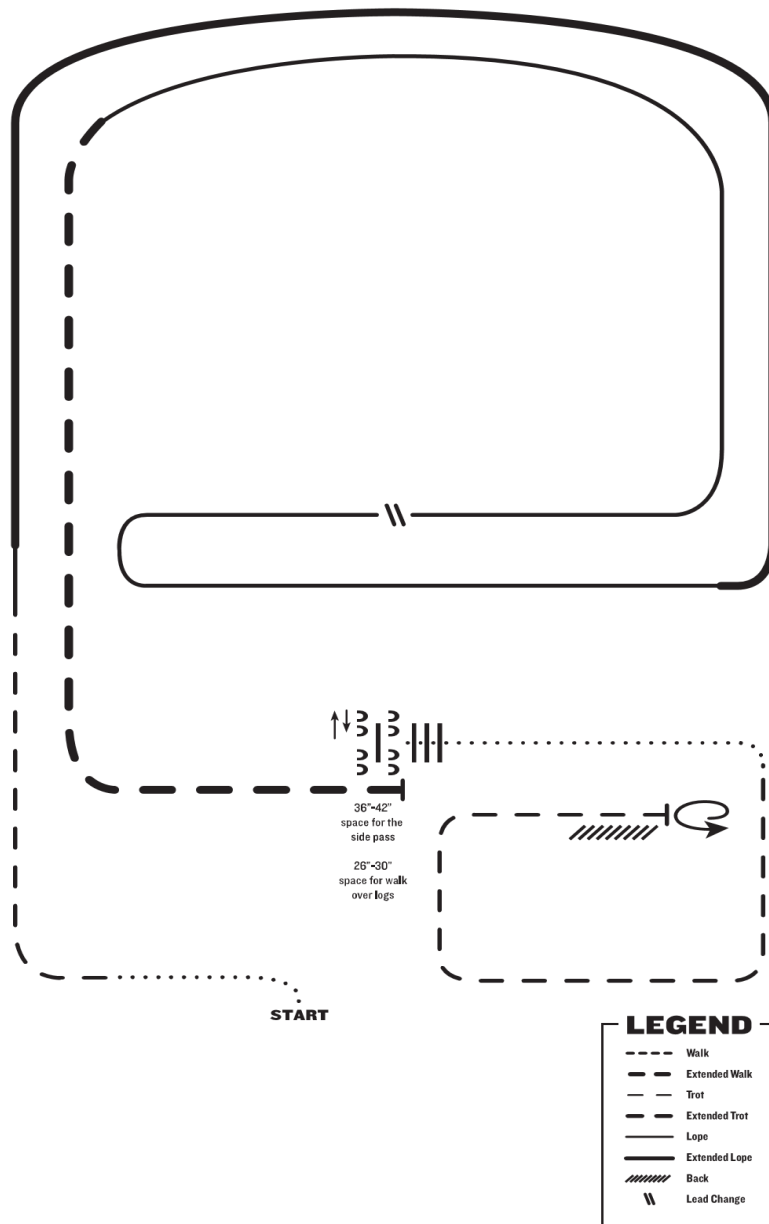

1. Walk
2. Trot
3. Extended lope right lead
4. Lope right lead
5. Change leads (simple or flying)
6. Lope left lead
7. Extended trot
8. Stop, side pass left, side pass right, 1/2 way
9. Walk over logs
10. Walk
11. Trot square
12. Stop, 360° turn left, and back

Note: The drawn description of this pattern is only intended for the general depiction of the pattern. Exhibitors should utilize the arena space to best exhibit their horses.

RANCH RIDING PATTERN 5

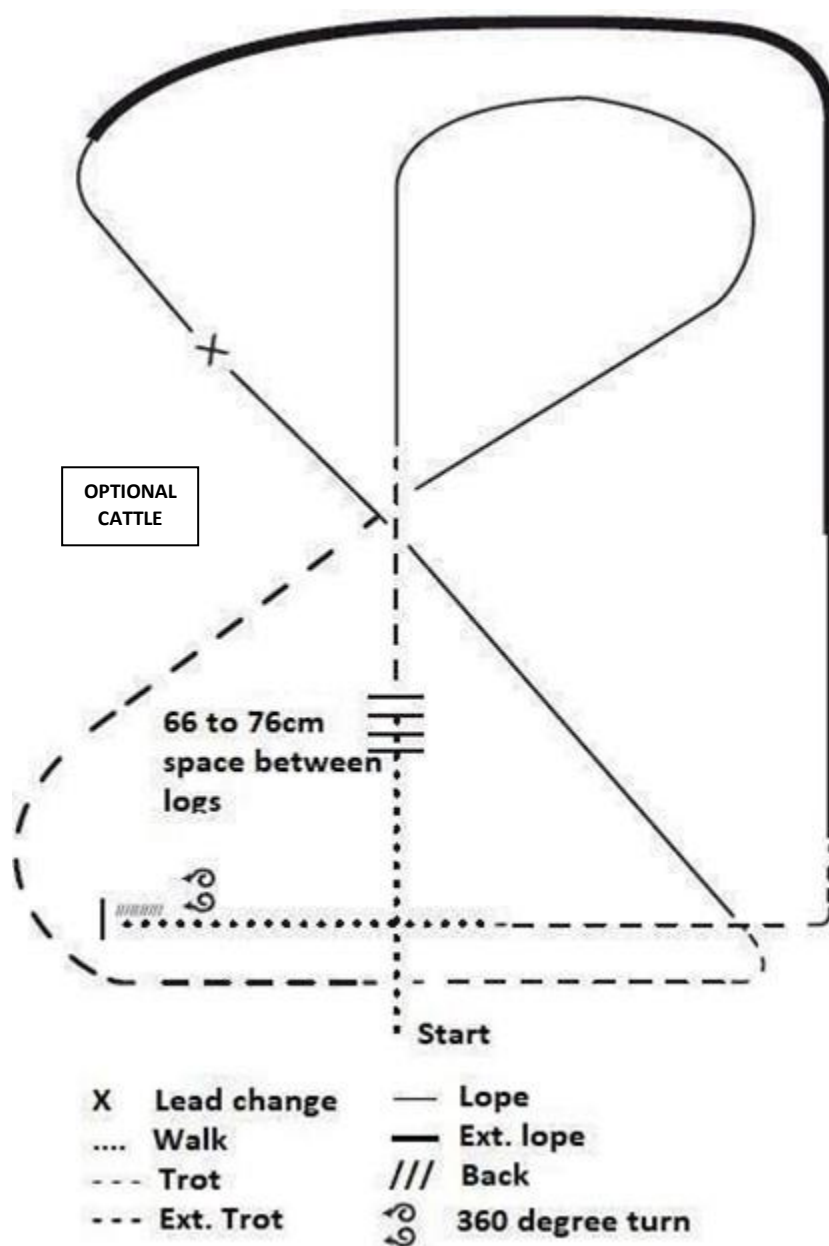

1. Walk
2. Walk over logs
3. Trot
4. Lope right lead
5. Extended trot
6. Trot
7. Lope left lead
8. Change leads (simple or flying)
9. Right lead, extended lope
10. Collect lope
11. Trot
12. Walk
13. Stop and back
14. 360° turn each direction (either direction first) (L-R or R-L)

RANCH RIDING PATTERN 6

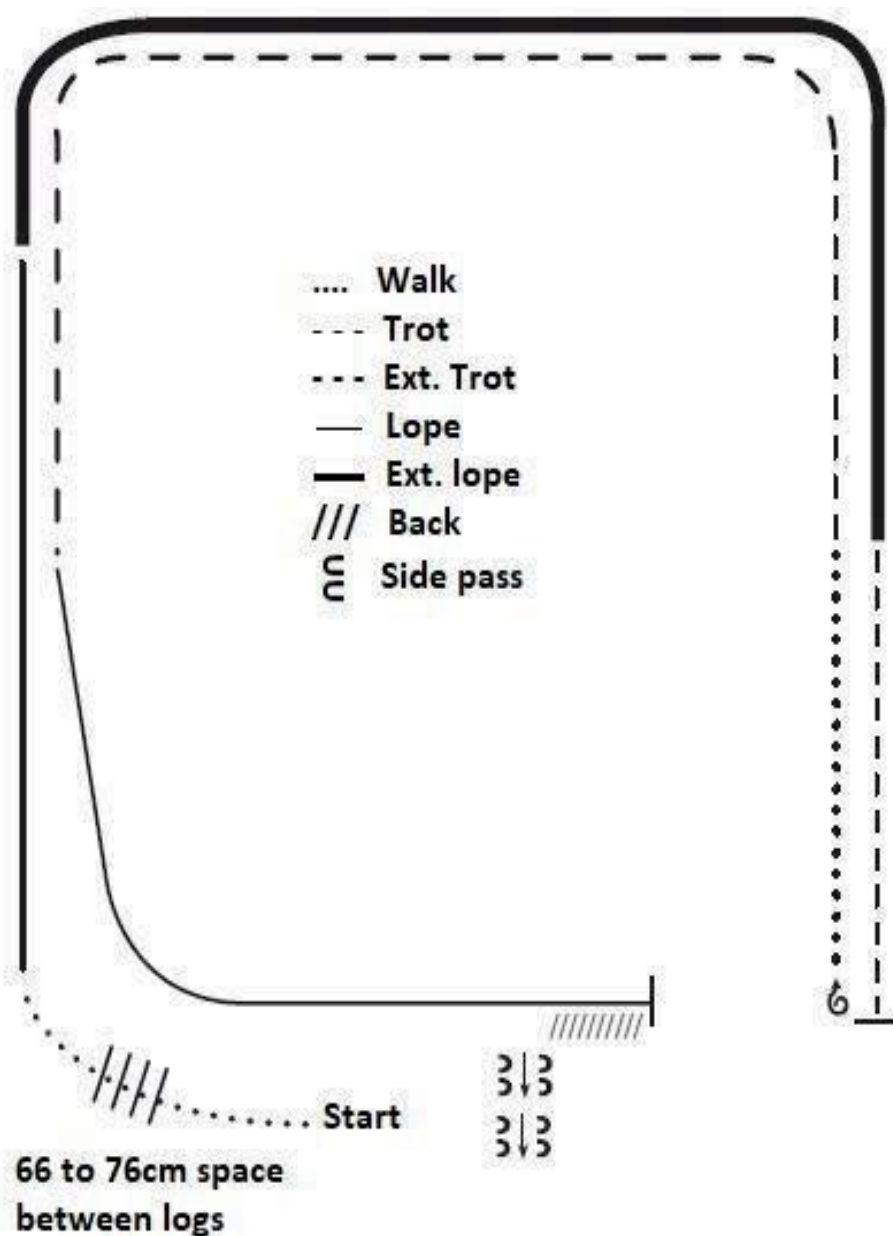

1. Walk
2. Walk over logs
3. Lope right lead
4. Extended lope right lead
5. Trot
6. Stop, 1½ turns right
7. Walk
8. Trot
9. Extended trot
10. Lope left lead
11. Stop and back
12. Side pass right

RANCH RIDING PATTERN 7

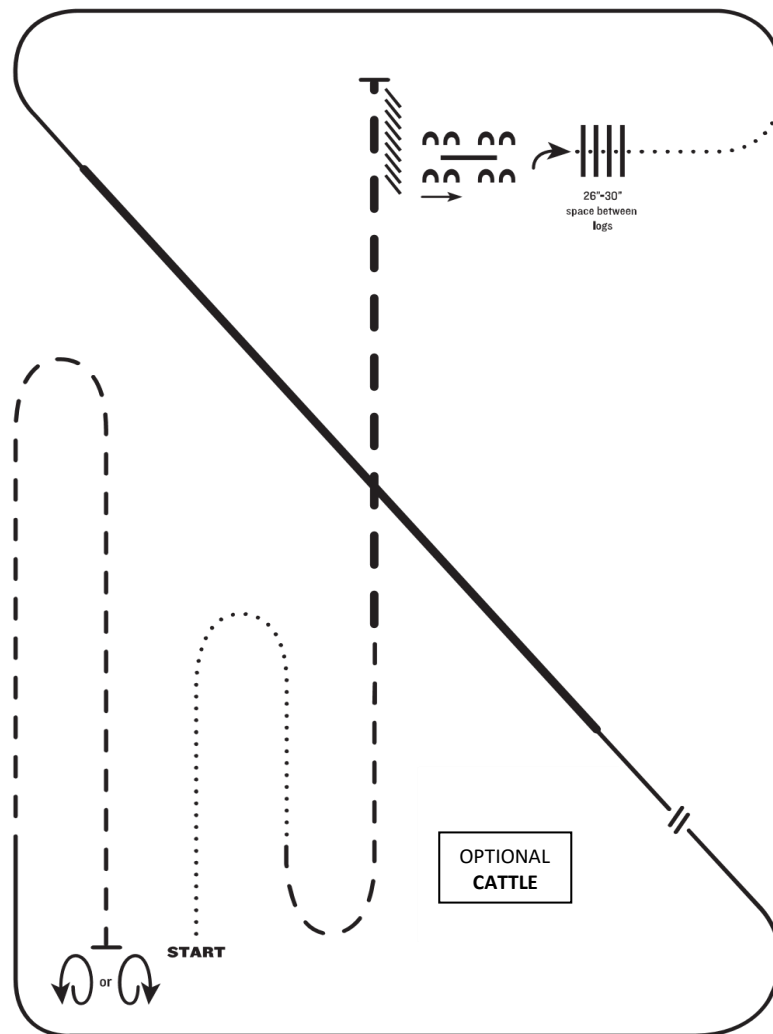

LEGEND	
----	Walk
- - - -	Extended Walk
- · - ·	Trot
- · - ·	Extended Trot
— — — —	Lope
— — — —	Extended Lope
////	Back
W	Lead Change

1. Walk
2. Trot
3. Extended trot
4. Stop and back
5. Side pass right over log
6. 1/4 turn right, walk over logs
7. Walk
8. Lope left lead
9. Extended lope left lead
10. Collect lope, change leads (simple or flying)
11. Lope right lead
12. Trot
13. Stop, one 360° turn either direction

Note: The drawn description of this pattern is only intended for the general depiction of the pattern. Exhibitors should utilize the arena space to best exhibit their horses.

RANCH RIDING PATTERN 8

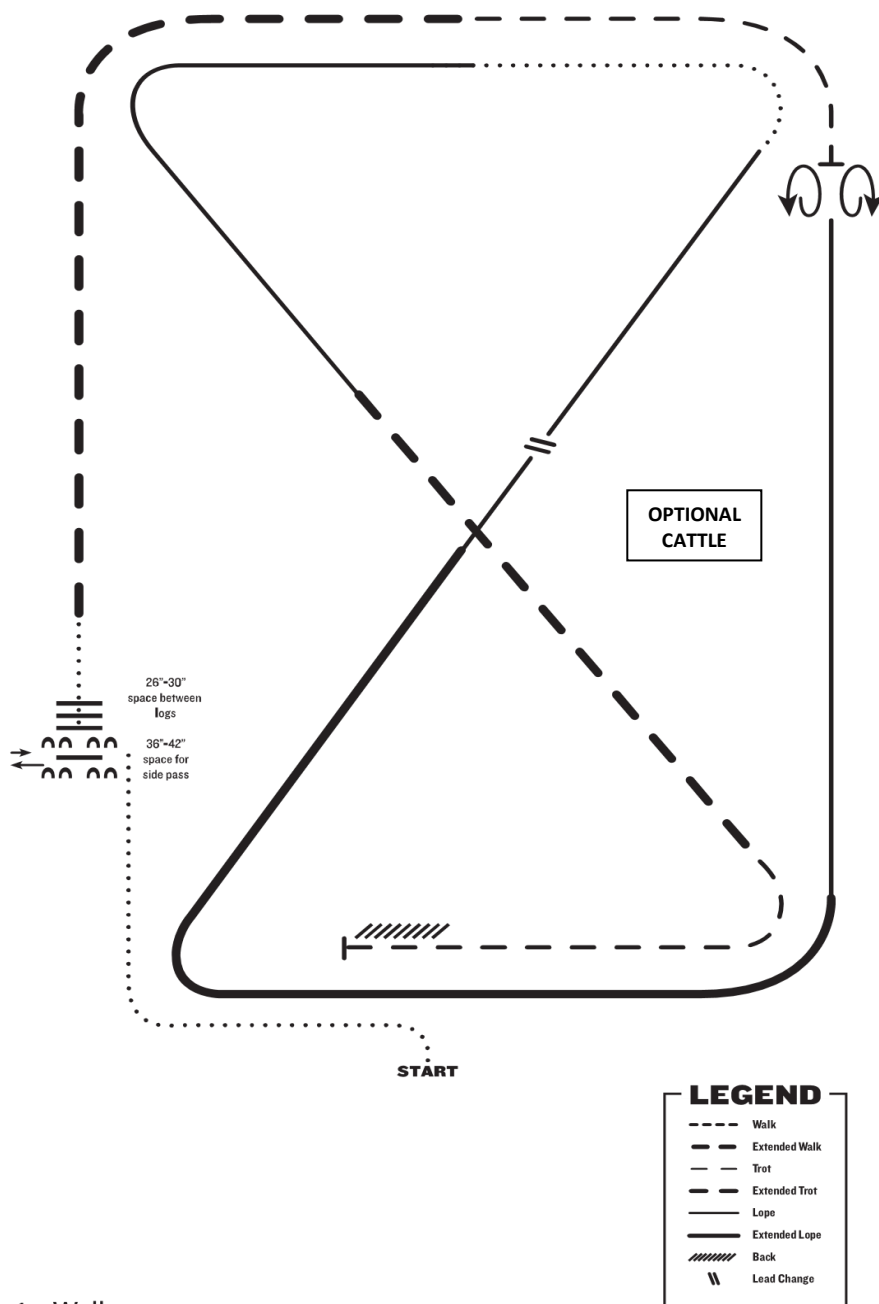

1. Walk
2. Side pass left across first log, side pass 1/2 way to right
3. Walk over logs
4. Extended trot
5. Trot
6. Stop, 360° turn each direction (either direction 1st) (L-R or R-L)
7. Lope right lead
8. Extended lope right lead
9. Collect lope, change leads (simple or flying), continue lope left lead
10. Walk
11. Lope left lead
12. Extended trot
13. Trot
14. Stop and back

Note: The drawn description of this pattern is only intended for the general depiction of the pattern. Exhibitors should utilize the arena space to best exhibit their horses.

RANCH RIDING PATTERN 9

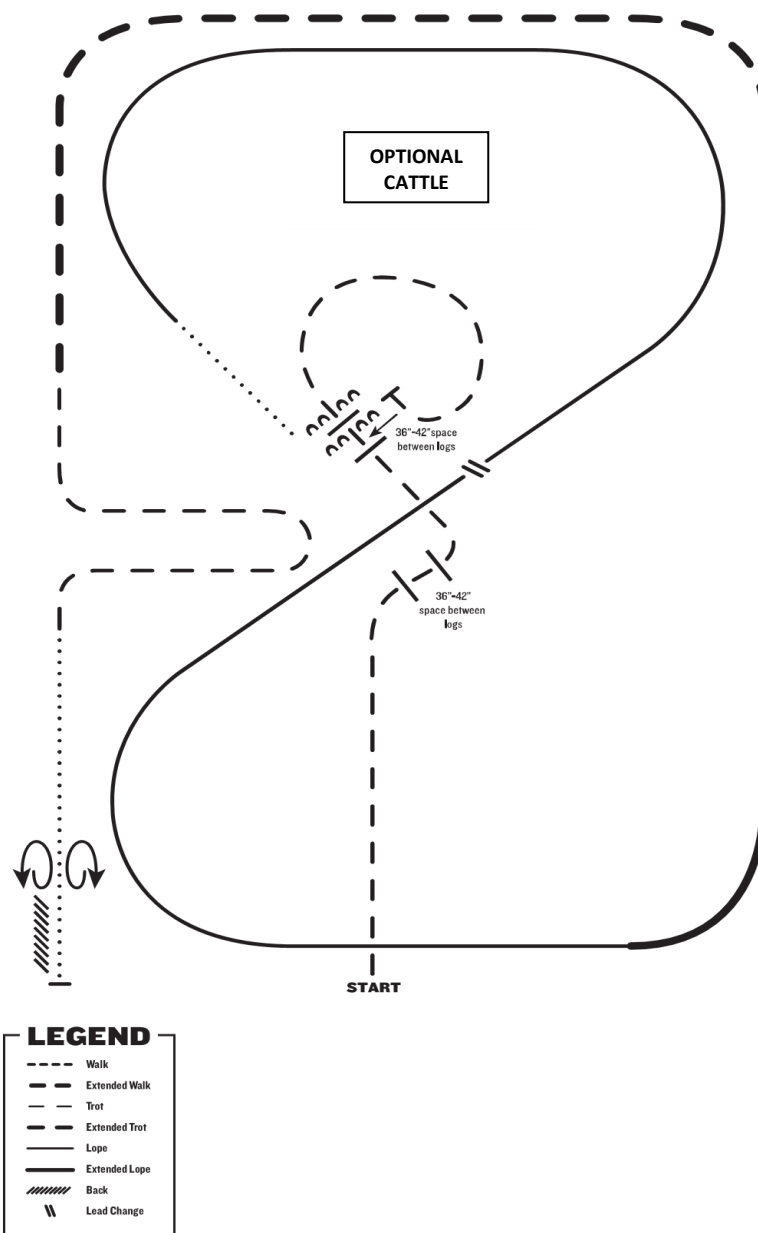

1. Trot
2. Trot over two sets of logs
3. Trot circle, stop and side pass left over log
4. Walk
5. Lope right lead
6. Change leads (simple or flying)
7. Lope left lead
8. Extended lope left lead
9. Extended trot
10. Trot
11. Walk
12. Stop and back
13. 360° turn each direction (either direction 1st) (L-R or R-L)

Note: The drawn description of this pattern is only intended for the general depiction of the pattern. Exhibitors should utilize the arena space to best exhibit their horses.

RANCH RIDING PATTERN 10

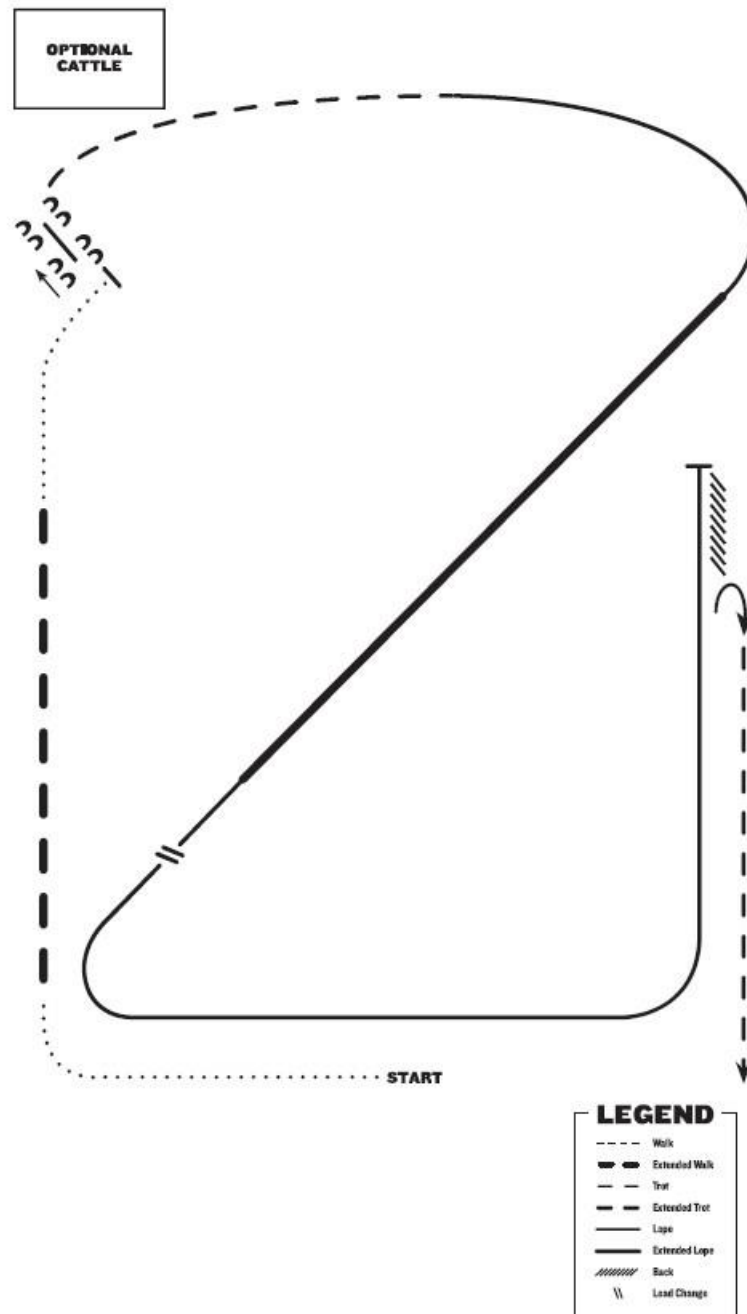

1. Walk
2. Extended trot
3. Walk
4. Stop, side pass left over log
5. Trot
6. Lope right lead
7. Extended lope right lead
8. Collect lope and change leads (simple or flying)
9. Lope left lead
10. Stop and back
11. 1/2 turn right
12. Trot

Note: The drawn description of this pattern is only intended for the general depiction of the pattern. Exhibitors should utilize the arena space to best exhibit their horses.

RANCH RIDING PATTERN 11

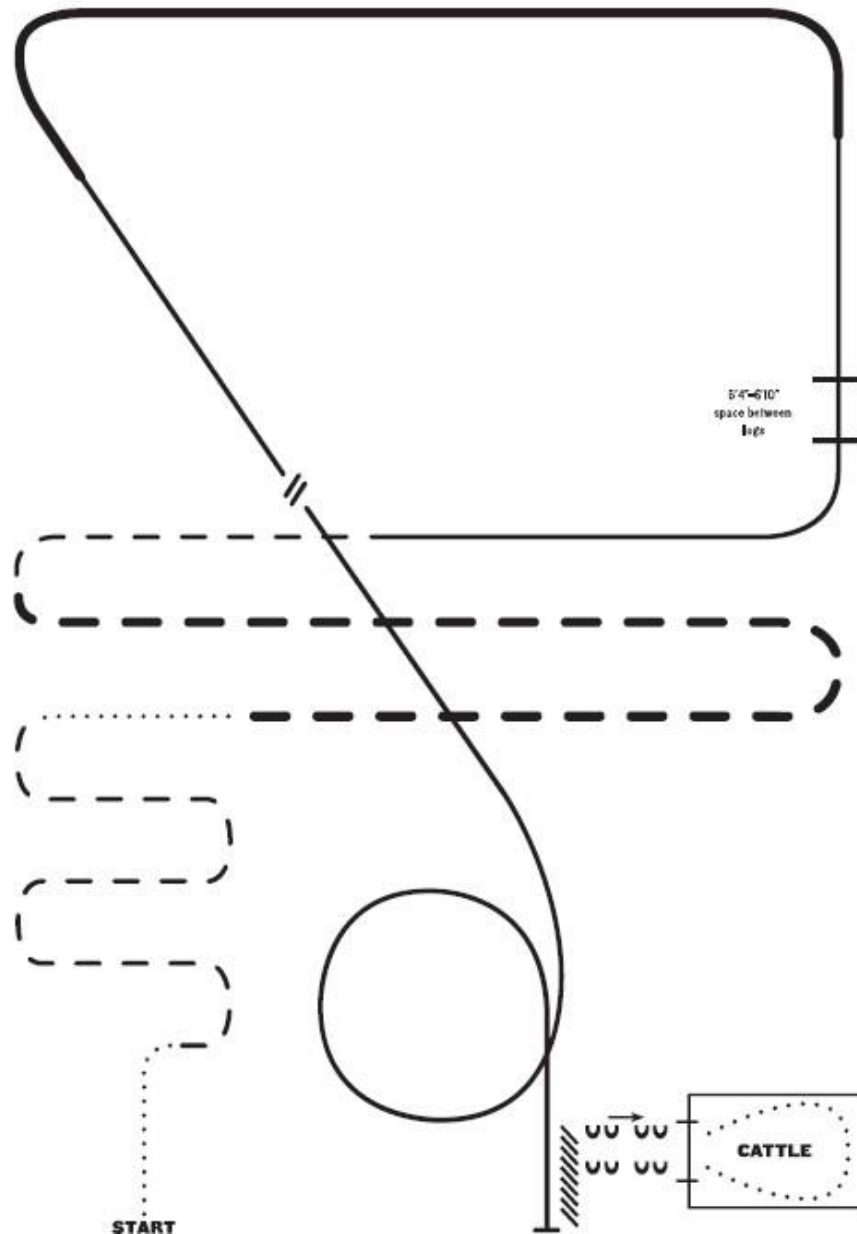

1. Walk
2. Trot serpentine
3. Walk
4. Extended trot
5. Trot
6. Lope left lead
7. Lope over logs
8. Extended lope left lead
9. Collect lope, change leads (simple or flying)
10. Lope right lead
11. Lope circle
12. Stop and back
13. Side pass to gate, left hand push into pen
14. Walk through cattle, right hand push out

LEGEND	
---	Walk
—	Extended Walk
- - -	Trot
- - -	Extended Trot
—	Lope
—	Extended Lope
////	Back
//	Lead Change

Note: The drawn description of this pattern is only intended for the general depiction of the pattern. Exhibitors should utilize the arena space to best exhibit their horses.

RANCH RIDING PATTERN 12

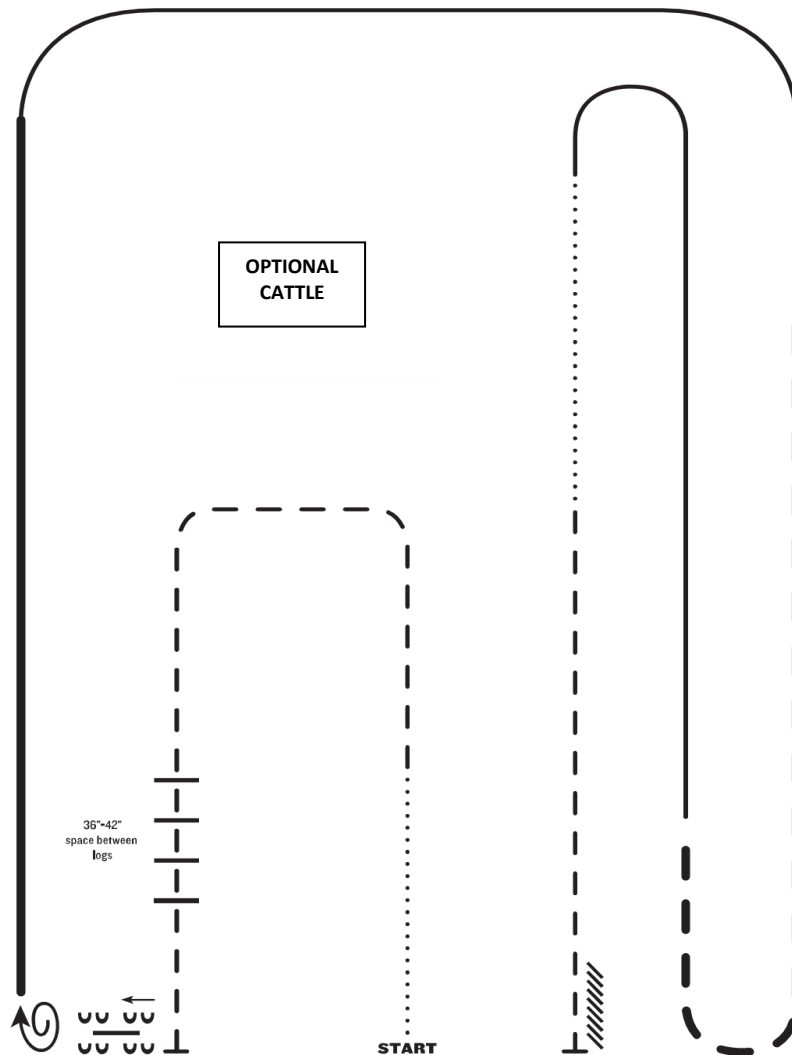

LEGEND

----	Walk
- - - -	Extended Walk
- . - .	Trot
- - - -	Extended Trot
— — — —	Lope
— — — —	Extended Lope
////	Back
W	Lead Change

1. Walk
2. Trot
3. Trot over logs, stop
4. Side pass right over log
5. 1 1/2 turn right
6. Extended lope right lead
7. Lope right lead
8. Extended trot
9. Lope left lead
10. Walk
11. Trot
12. Stop and back

Note: The drawn description of this pattern is only intended for the general depiction of the pattern. Exhibitors should utilize the arena space to best exhibit their horses.

RANCH RIDING PATTERN 13

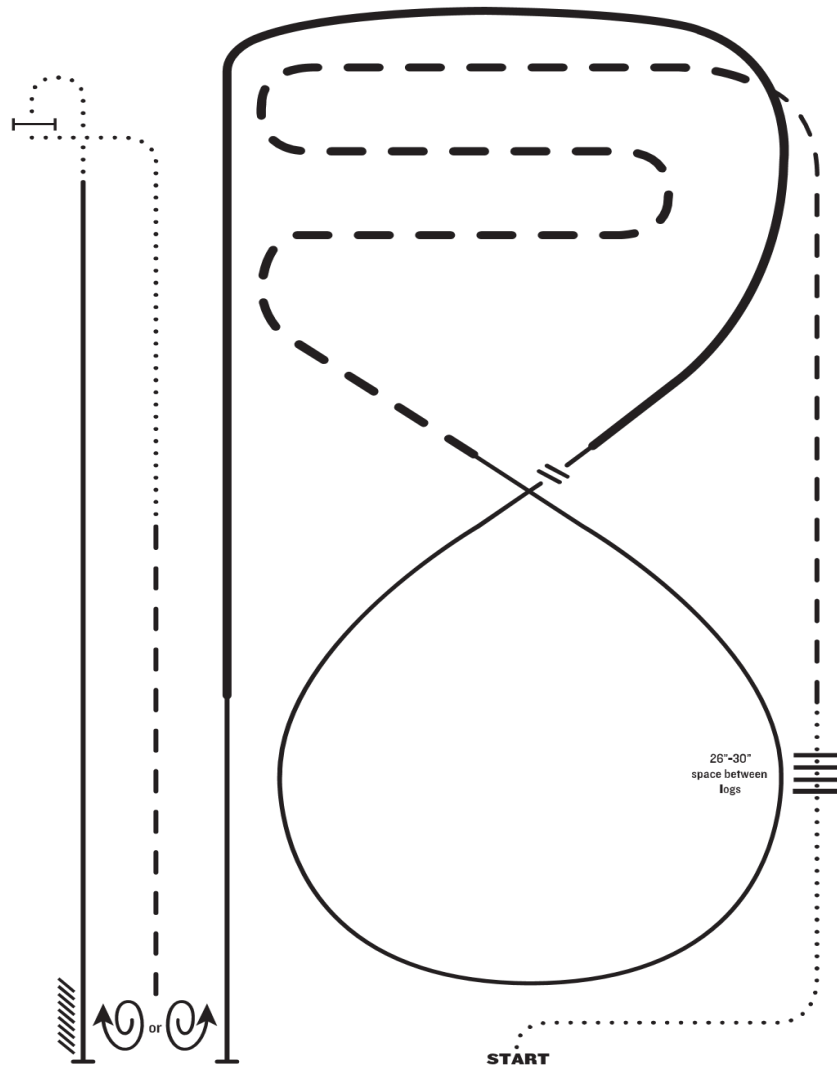

LEGEND	
----	Walk
- - - -	Extended Walk
- · - ·	Trot
- · - ·	Extended Trot
— — —	Lope
— — —	Extended Lope
////	Back
W	Lead Change

1. Walk
2. Walk over logs
3. Trot
4. Extended trot serpentine
5. Lope right lead
6. Change leads (simple or flying)
7. Extended lope left lead, collect lope
8. Stop, 1 1/2 turn either direction
9. Trot
10. Walk to gate
11. Right hand push gate
12. Walk, lope left lead
13. Stop and back

Note: The drawn description of this pattern is only intended for the general depiction of the pattern. Exhibitors should utilize the arena space to best exhibit their horses.

RANCH RIDING PATTERN 14

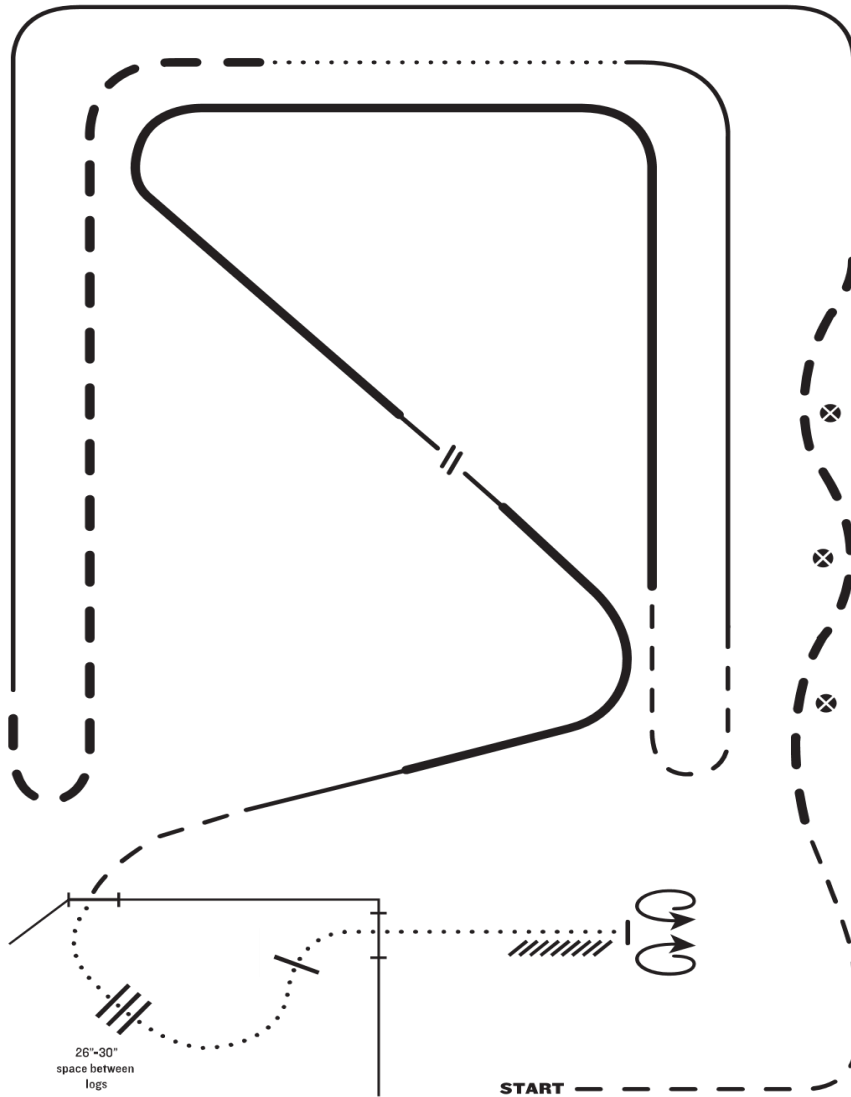

1. Trot
2. Extended trot
3. Lope left lead
4. Extended trot
5. Walk
6. Lope right lead
7. Trot
8. Extended lope left lead
9. Collect lope, change leads (simple or flying), extended lope right lead, collect lope
10. Trot
11. Left hand push gate into pen
12. Walk over logs
13. Right hand push gate out of pen
14. Walk
15. Stop, 360° turn each direction (either direction 1st) (L-R or R-L)
16. Back

LEGEND	
----	Walk
- - - -	Extended Walk
- · - ·	Trot
- · - ·	Extended Trot
— · — ·	Lope
— · — ·	Extended Lope
////	Back
∩	Lead Change

Note: The drawn description of this pattern is only intended for the general depiction of the pattern. Exhibitors should utilize the arena space to best exhibit their horses.

RANCH RIDING PATTERN 15

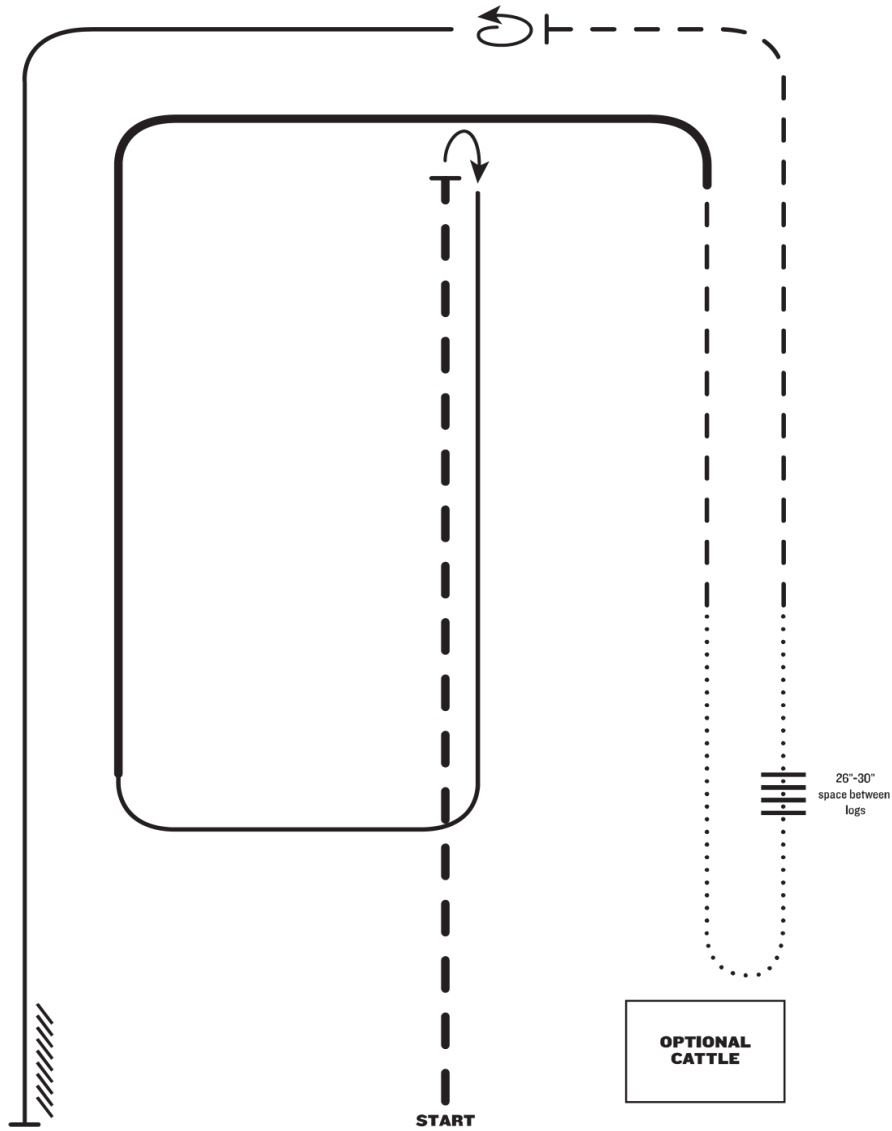

1. Extended trot
2. Stop, rollback right
3. Lope right lead
4. Extended lope right lead
5. Trot
6. Walk
7. Walk over logs
8. Walk
9. Trot
10. Stop, 360° turn left
11. Lope left lead
12. Stop and back

LEGEND

----	Walk
- - - -	Extended Walk
----	Trot
- - - -	Extended Trot
----	Lope
=====	Extended Lope
////	Back
\\	Lead Change

Note: The drawn description of this pattern is only intended for the general depiction of the pattern. Exhibitors should utilize the arena space to best exhibit their horses.

RANCH RIDING - PATTERN 16 (WALK / JOG)

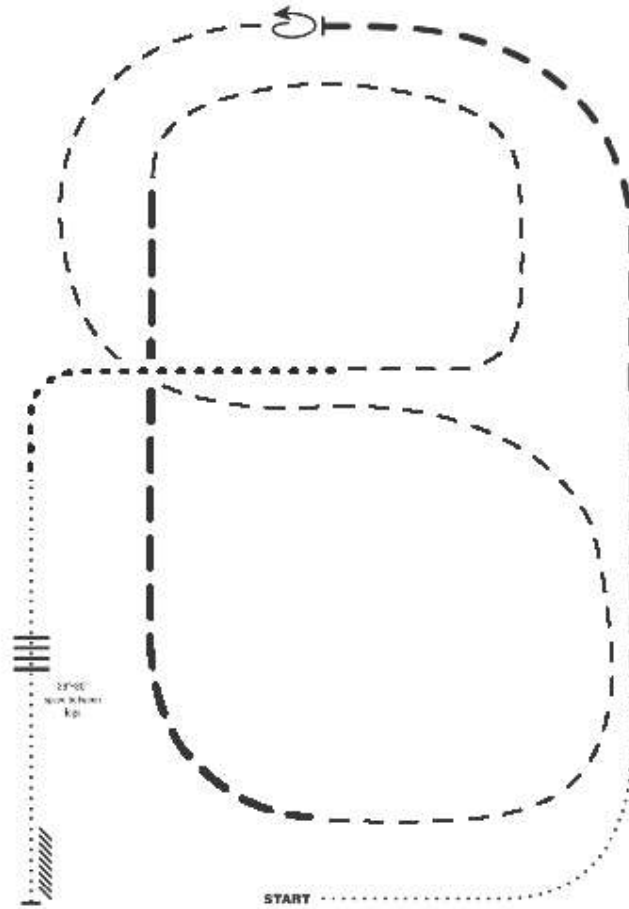

LEGEND

-----	Walk
- - - - -	Extended Walk
- - - - -	Trot
- - - - -	Extended Trot
-----	Log
-----	Control Line
-----	Back
W	Level Change

Note: The drawn description of this pattern is only intended for the general depiction of the pattern. Exhibitors should utilize the arena space to best exhibit their horses.

1. Walk
2. Trot
3. Extend the trot, at the top of the arena, stop
4. 360° turn left
5. Trot serpentine
6. Extended trot up the long side of the arena
7. Collect back to trot around the top of the arena and back to center
8. Break down to an extended walk
9. Walk over logs
10. Stop and back

RANCH RIDING - PATTERN 17 (WALK / JOG)

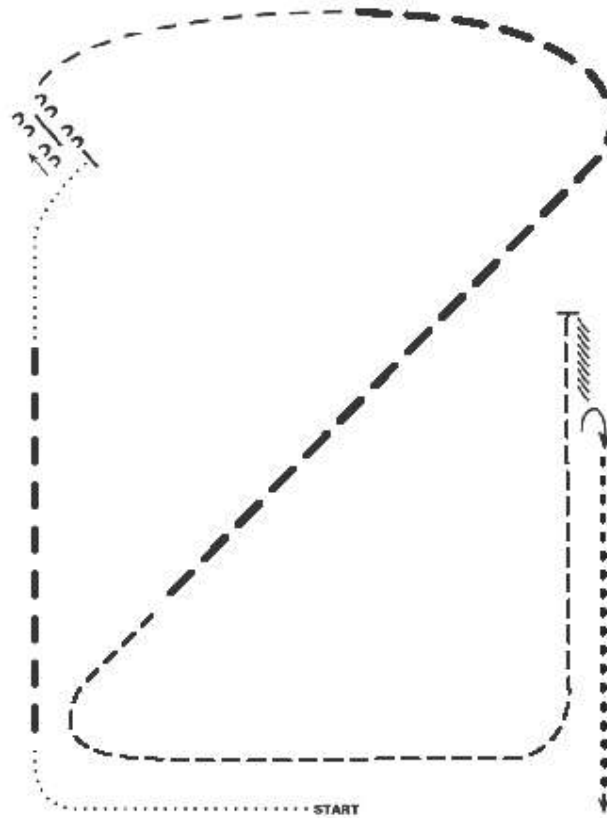

1. Walk
2. Extended trot
3. Walk
4. Stop, side pass left over log
5. Trot
6. Extended trot
7. Collect trot
8. Stop and back
9. 1/2 turn right
10. Extended walk

LEGEND	
----	Walk
----	Extended Trot
----	Trot
----	Extended Trot
----	Stop
----	Extended Walk
----	Back
W	1/2 turn right

Note: The drawn description of this pattern is only intended for the general depiction of the pattern. Exhibitors should utilize the arena space to best exhibit their horses.

RANCH PLEASURE - PATTERN (WALK / JOG)

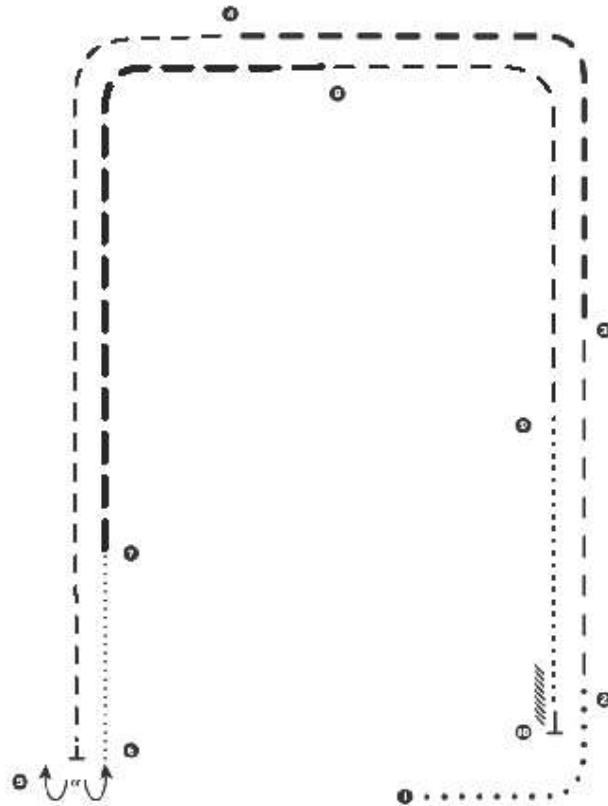

LEGEND	
-----	Walk
-----	Controlled Walk
-----	Trot
-----	Controlled Trot
-----	Lope
-----	Controlled Lope
-----	Stop

When establishing the course, the following distances are suggested. Patterns may begin in either direction and markers are optional.

1. Extended Walk from 1 to 2 - 75 feet
2. Trot from 2 to 3 - 120 feet
3. Extended Trot from 3 to 4 - 240 feet
4. Trot from 4 to 5 - 150 feet
5. Stop at 5; reverse (either direction)
6. Walk from 6 to 7 - 30 feet
7. Extended Trot from 7 to 8 - 150 feet
8. Trot from 8 to 9 - 200 feet
9. Walk from 9 to 10 - 90 feet
- 10 Stop and Back at 10 - approximately one horse length

Note: The drawn description of this pattern is only intended for the general depiction of the pattern. Exhibitors should utilize the arena space to best exhibit their horses.

RANCH PLEASURE PATTERN 1

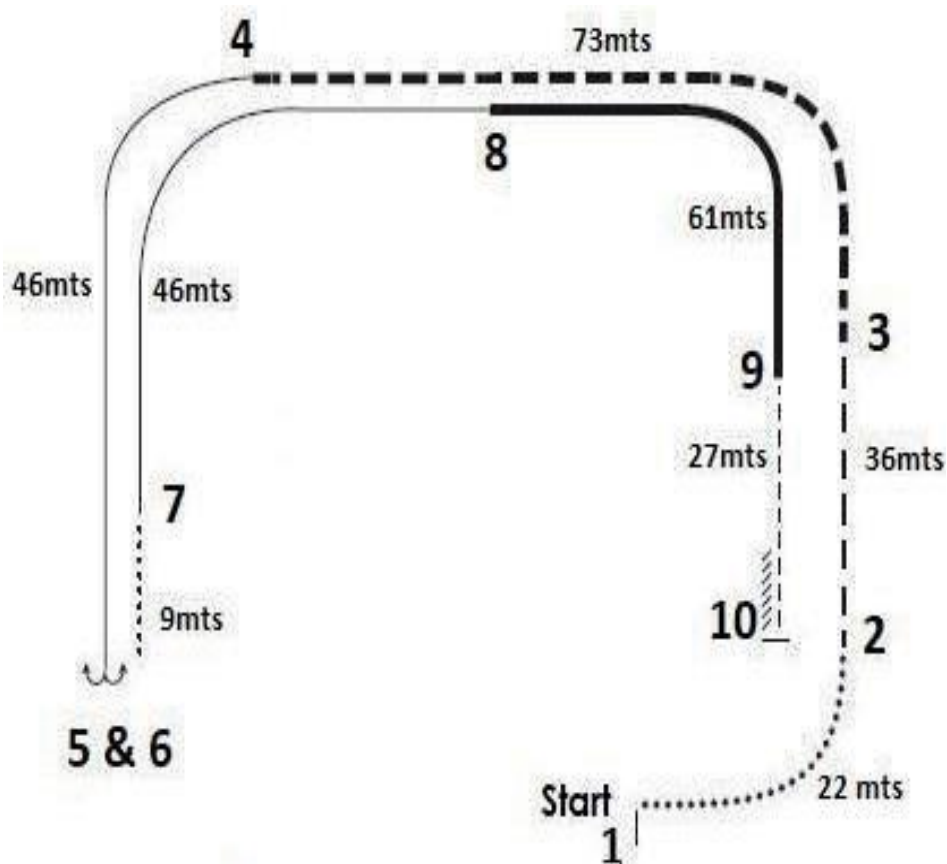

- Walk
- Ext. Walk
- Trot
- - - - Ext. Trot
- Lope
- Ext. Lope
- //// Back

The above distances are suggested, markers are optional

1. Extended walk from 1 to 2
2. Trot from 2 to 3
3. Extended trot from 3 to 4
4. Lope from 4 to 5
5. Stop at 5. reverse (either direction)
6. Walk from 6 to 7
7. Lope from 7 to 8
8. Extended lope from 8 to 9
9. Trot from 9 to 10
10. Stop at 10 and back approximately one (1) horse length

RANCH PLEASURE PATTERN 2

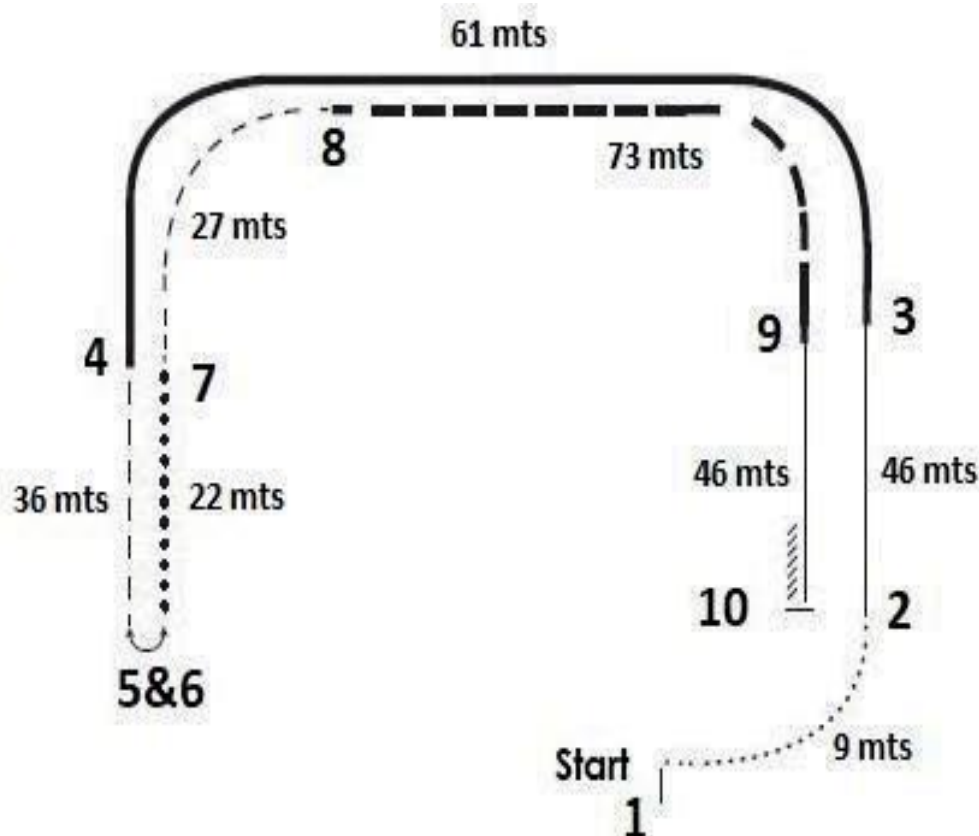

- Walk
- Ext. Walk
- Trot
- Ext. Trot
- Lope
- Ext. Lope
- //// Back

The above distances are suggested and markers are optional

1. Walk from 1 to 2
2. Lope from 2 to 3
3. Extend lope from 3 to 4
4. Trot from 4 to 5
5. Stop at 5, reverse (either direction)
6. Extend walk from 6 to 7
7. Trot from 7 to 8
8. Extend trot from 8 to 9
9. Lope from 9 to 10
10. Stop at 10 and back approximately one (1) horse length

RANCH PLEASURE PATTERN 3

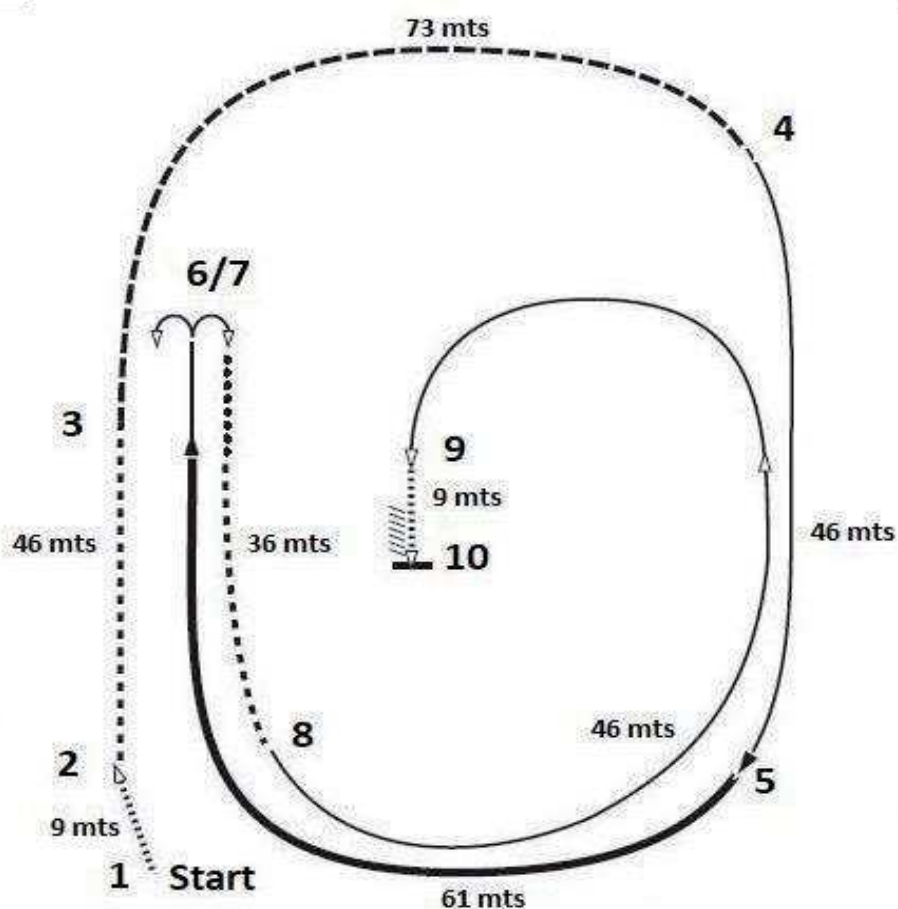

- Walk
- Ext. Walk
- Trot
- Ext. Trot
- Lope
- Ext. Lope
- //// Back

The above measurements are suggested and markers are optional

1. Walk from 1 to 2
2. Trot from 2 to 3
3. Extend trot from 3 to 4
4. Lope on right lead 4 to 5
5. Extend lope from 5 to 6 (collect lope before stopping)
6. Stop at 6 and reverse either direction
7. Trot from 7 to 8
8. Lope on left lead from 8 until even with 9, turn towards middle of arena and continue on left lead to 9
9. Walk from 9 to 10
10. Stop at 10 and back approximately one (1) horse length

RANCH REINING PATTERN 1

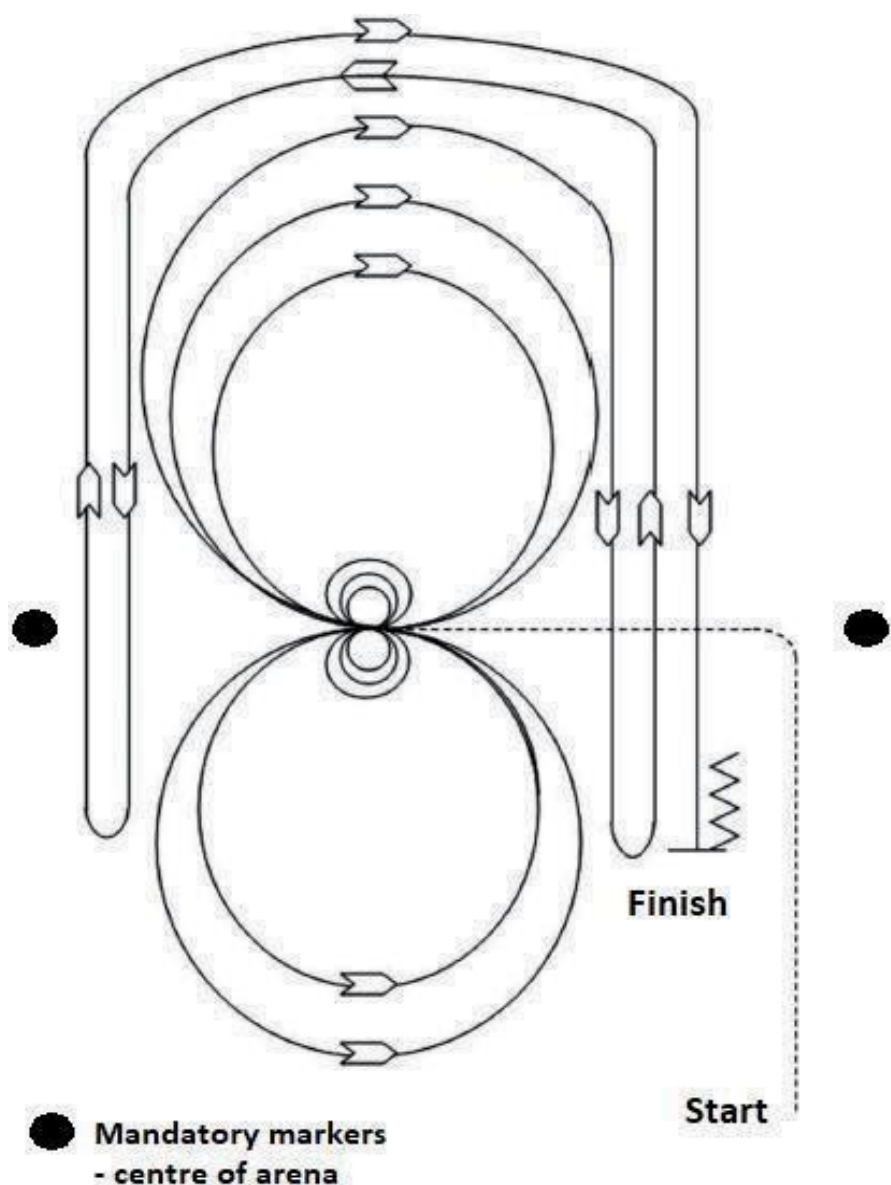

- Ride pattern as follows: Trot to centre of arena and stop.
1. Complete three (3) spins in one direction. Hesitate
 2. Complete three (3) spins in the opposite direction. Hesitate
 3. Beginning on right lead, complete two (2) large fast circles to the right. Change leads at centre of arena
 4. Complete two (2) large fast circles to the left. Change leads at centre of arena
 5. Begin a large circle to the right but do not close this circle. Run down right side of arena past centre marker and do a left rollback at least 6 m from the wall, no hesitation
 6. Continue back around the previous circle but do not close this circle. Run down left side of arena past centre marker and do a right rollback at least 6 m from wall, no hesitation
 7. Continue back around previous circle, but do not close this circle. Run down right side of arena past centre marker and do a sliding stop at least 6 m from the wall. Back up at least 3 m. Hesitate to show completion of pattern

RANCH REINING PATTERN 2

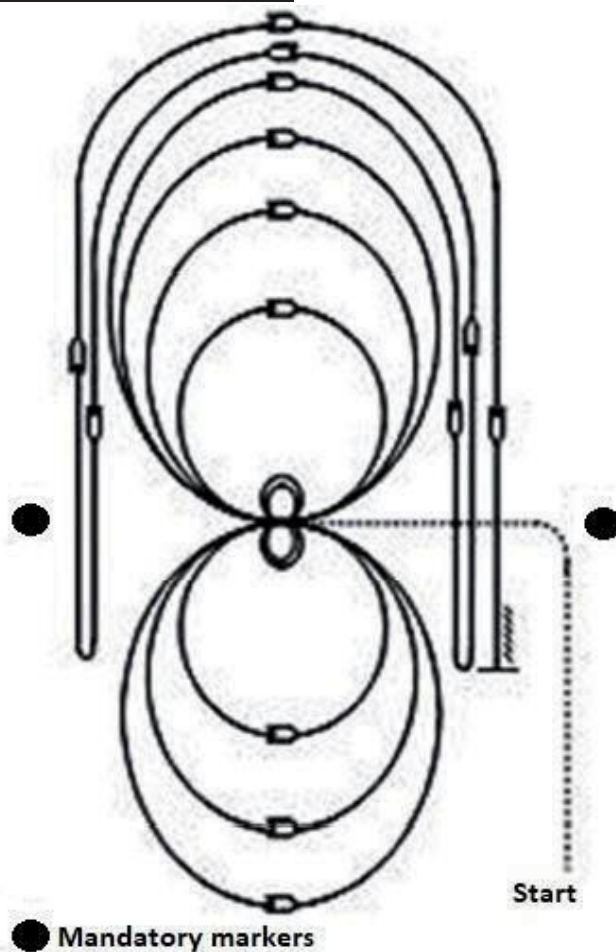

Ride pattern as follows: Trot to centre of arena and stop or walk before departure.

1. Beginning on right lead complete two (2) circles to the right, the first one large and fast, the second small and slow. Stop at centre
2. Complete four (4) spins to the right. Hesitate.
3. Beginning on left lead complete two (2) circles to the left, the first large and fast, the second small and slow. Stop at centre
4. Complete four (4) spins to the left. Hesitate
5. Beginning on right lead complete a large fast circle to the right and change leads at centre of arena. Complete a large fast circle to the left and change leads at centre of arena
6. Begin a large fast circle to the right, but do not close this circle. Run down right side of arena past centre marker and do a left rollback at least 6 m from wall
7. Continue back around previous circle but do not close this circle. Run down left side of arena past centre marker and do a right rollback at least 6 m from wall
8. Continue back around previous circle but do not close this circle. Run down right side of arena past centre marker and do a sliding stop at least 6 m from wall. Back up at least 3m. Hesitate to show completion of pattern.

RANCH REINING PATTERN 3

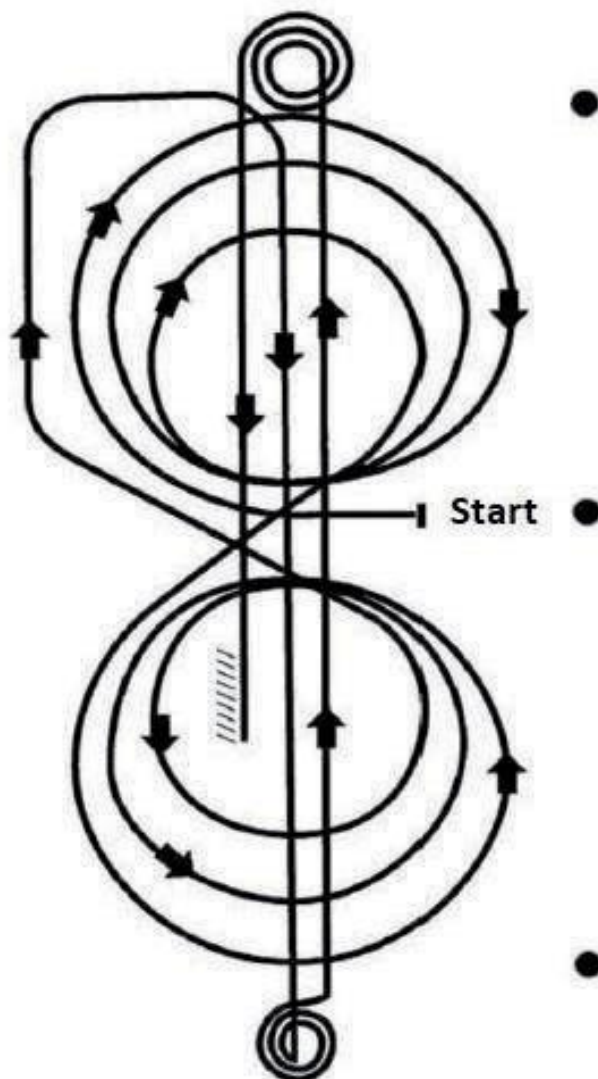

- **Mandatory Markers - centre and at least 15 metres from each end of arena**

Ride pattern as follows: Trot to centre of arena and stop or walk before departure. Start pattern facing toward the Judge.

1. Beginning on right lead, complete three (3) circles to the right – the first two large and fast. the third small and slow. Change leads at centre of arena
2. Complete three (3) circles to the left: the first two large and fast, the third small and slow. Change leads at centre of arena
3. Begin a large circle to the right, but do not close this circle. Run down centre of arena, past end marker, and do a sliding stop
4. Complete 3½ spins to the right
5. Run up centre of arena to the opposite end, past end marker, do a sliding stop
6. Complete 3½ spins to the left
7. Run back to middle of arena, past centre marker and do a sliding stop. Back up at least 3 m. Hesitate to show completion of pattern.

RANCH REINING PATTERN 4

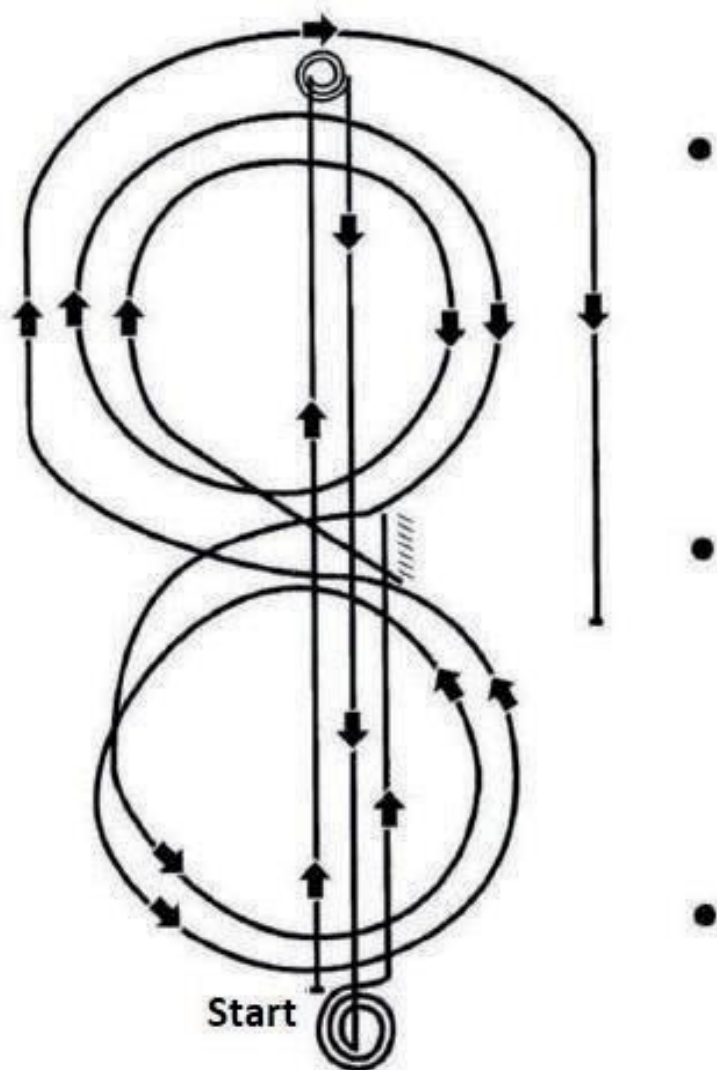

- **Mandatory markers - centre and at least 15 metres from each end of arena**

Ride pattern as follows:

1. Run up centre of arena past end marker and do a sliding stop
2. Complete 3½ spins to the left
3. Run down to opposite end of arena, past end marker and do a sliding stop
4. Complete 3½ spins to the right
5. Run past centre marker and do a sliding stop. Back at least 3 m. Complete ¼ turn to the left. Hesitate
6. Beginning on right lead, complete two (2) circles to the right – the first small and slow, the second large and fast. Change leads at centre of arena
7. Complete two (2) circles to the left – the first small and slow, the second large and fast. Change leads at centre of arena
8. Begin a large circle to the right, but do not close circle. Run down right side of arena past centre marker and do a sliding stop at least 6 m from the fence. Hesitate to show completion of pattern.

RANCH REINING PATTERN 5

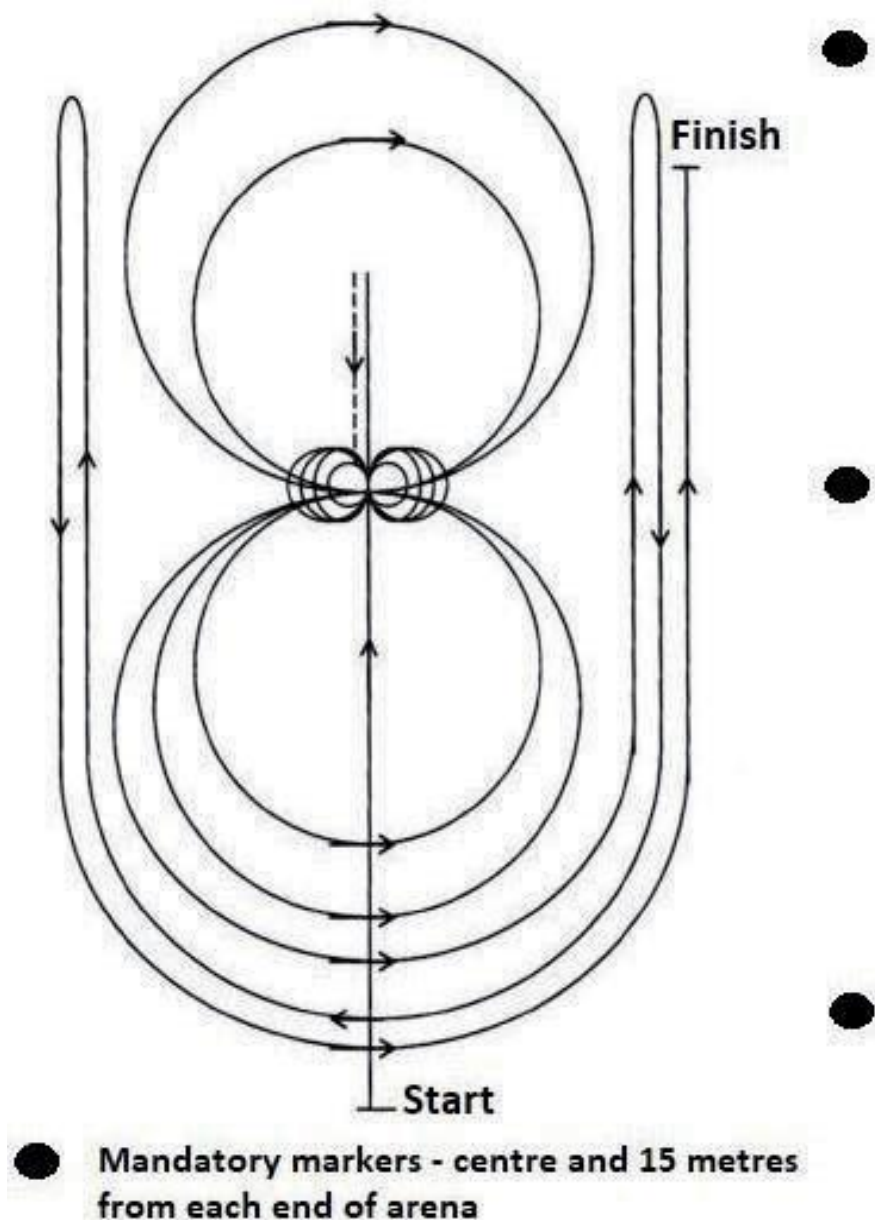

Ride pattern as follows:

1. Run past centre marker and do a sliding stop. Back to centre of arena or at least 3 m. Hesitate
2. Complete four (4) right spins. Hesitate
3. Complete 4¼ left spins. Hesitate. Horse to be facing left wall
4. Beginning on left lead, complete two (2) circles to the left – the first small and slow, the second large and fast Change leads at centre of arena
5. Complete two (2) circles to the right – the first small and slow, the second large and fast. Change leads at centre of arena
6. Begin a large circle to the left, but do not close circle. Run up left side of arena past centre marker and do a right rollback at least 6 m from wall
7. Continue back around the previous circle, but do not close circle. Run up left side of arena past centre marker and do a left rollback at least 6 m from wall
8. Continue back around previous circle but do not close circle. Run up right side of arena past centre marker, and do a sliding stop at least 6 m from wall. Hesitate to show completion of pattern

RANCH REINING PATTERN 6

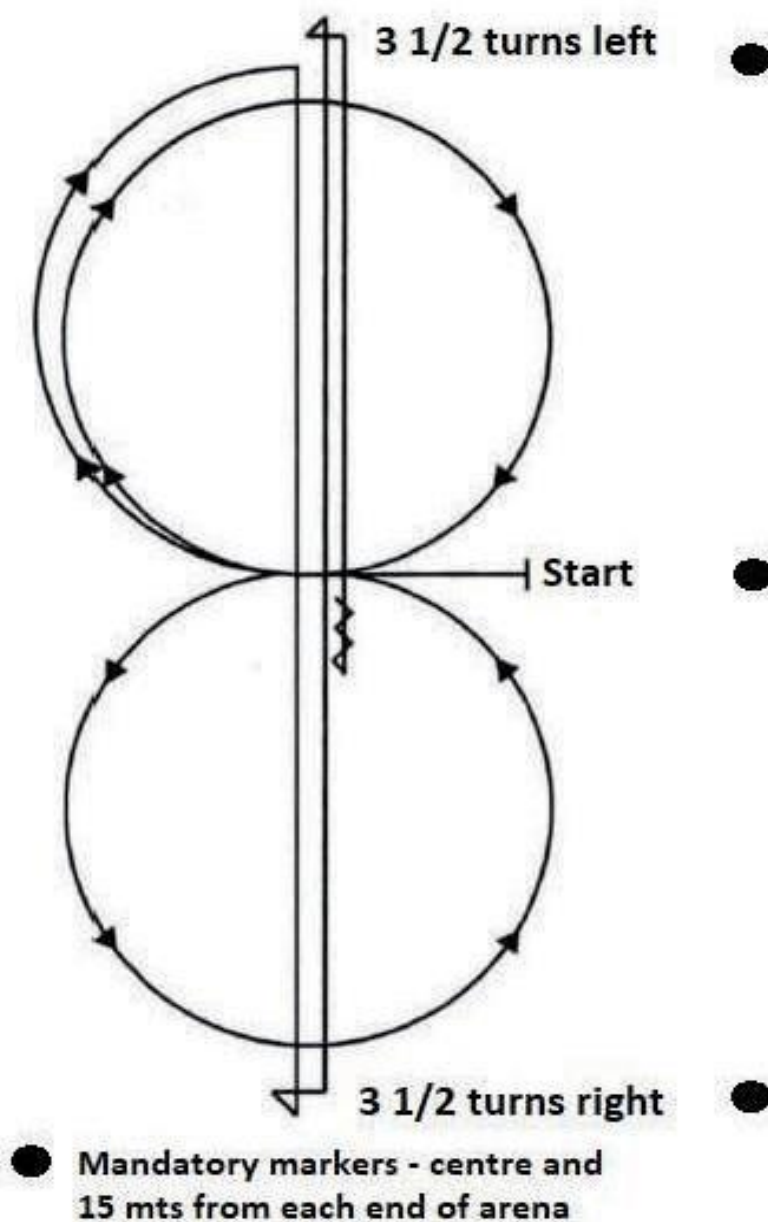

● **Mandatory markers - centre and 15 mts from each end of arena**

Ride pattern as follows: Trot to centre of arena and stop or walk before departure. Start pattern facing toward Judge.

1. Beginning on right lead, lope one (1) circle to the right. Change leads at centre of arena.
2. Complete one (1) circle to the left. Change leads at centre of arena.
3. Begin a circle to the right but do not close this circle. Run down centre of arena past end marker and do a sliding stop.
4. Complete 3½ spins to the right.
5. Run up to the other end of arena, past end marker and do a sliding stop.
6. Complete 3½ spins to the left.
7. Run past centre marker and do a sliding stop. Back at least 3 m. Hesitate to show completion of pattern.

RANCH REINING PATTERN 7

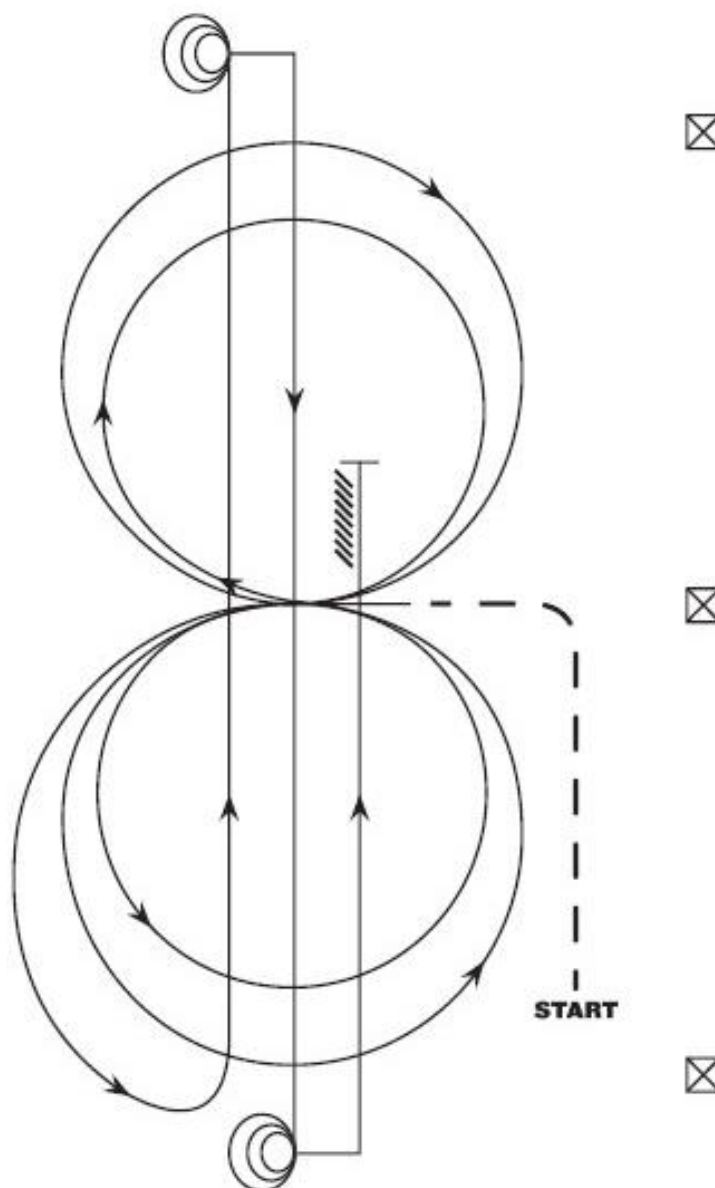

Mandatory Marker along Fence or Wall: The judge shall indicate with markers on arena wall or fence the center of pattern. Judge shall also place markers on fence or wall at least 50' from each end of the arena.

Ride pattern as follows: Trot to center of arena and stop or walk before departure. Start pattern facing toward judge.

1. Beginning on left lead, complete two circles to the left - the first one large and fast, the second one small and slow. Change leads at center of arena.
2. Complete two circles to the right - the first one large and fast, the second one small and slow. Change leads at center of arena.
3. Begin a circle to the left, but do not close this circle. Continuing around the end of arena, run up the center, past end marker, and do a sliding stop.
4. Complete 3 1/2 spins to the left.
5. Run down to other end of arena, past the end marker, and do a sliding stop.
6. Complete 3 1/2 spins to the right.
7. Run past the center marker and do a sliding stop. Back at least 10 feet. Hesitate to show completion pattern

